

OMRON®

INSTRUCTION MANUAL



IntelliSense™ Automatic Blood Pressure Monitor with Easy Wrap Cuff

Model **HEM-773AC**



TABLE OF CONTENTS

Introduction.....	3
Notes on Safety.....	4
Know Your Unit.....	5
Quick Reference Guide.....	6
Initial Set-Up	
Battery Installation/Replacement.....	7
How to Set Time and Date.....	8
How to Use the AC Adapter.....	9
Correct Usage	
How to Apply the Arm Cuff.....	10, 11
How to Take a Reading.....	12, 13
How to Use the Memory Function.....	14
Troubleshooting.....	15
Caution.....	16
Care and Maintenance.....	17
Warranty.....	18
Specifications.....	19

INTRODUCTION

Thank you for purchasing the Omron IntelliSense™ Automatic Blood Pressure Monitor with Easy Wrap Cuff, HEM-773AC. Although your blood pressure fluctuates throughout the day, no self-adjustment is necessary as the monitor intelligently adjusts to your changing conditions. The IntelliSense™ monitor uses fuzzy logic intelligence to sense both your systolic and diastolic blood pressure values, and the result is personalized inflation with every reading. Arm discomfort and misreading due to improper cuff inflation are virtually eliminated.

Your new OMRON monitor uses the oscillometric method of blood pressure measurement. This means the monitor detects your blood's movement through your brachial artery and converts the movements into a digital reading. At the press of a button, the monitor automatically fills the cuff with air, starts deflation, then displays your systolic, diastolic, and pulse readings on an extra large display panel.

Please read this instruction manual thoroughly before using this unit. For specific information on your own blood pressure, CONTACT YOUR PHYSICIAN.

NOTE:

This device is a digital monitor intended for the use in measuring blood pressure and pulse rate in adult population with the arm circumference ranging from 9 inches to 17 inches (from 23 cm to 43 cm).

NOTES ON SAFETY

- The warning signs and the sample icons shown here are listed for you to use the product safely and correctly as well as to prevent the risk and the damage to you and others from happening.
- The icons and meanings are as follow.

Warning sign	Contents
 Caution	Indicates matters in which bodily harm or material damage* may arise as a result of incorrect handling.

* Material damage refers to a wide range of damage involving your house, household goods, domestic animals, and pets.

Caution

Self-diagnosis of measured results and treatment are dangerous. Please follow the instructions of your doctor.

Do not use the unit on infants or persons who cannot express one's intention.

Do not use the unit for any purpose other than measuring blood pressure.

Do not use a cellular phone near the unit. Improper operation may result.

Do not disassemble, repair, or remodel the main unit or the arm cuff of the blood pressure monitor.

The battery liquid may leak and damage the main unit. Please observe the following points.

- When you are not going to use the unit for a long period of time (approximately three months or more), take out the batteries.
- Replace the worn batteries with new ones immediately.
- Do not use worn and new batteries together.
- Do not insert the batteries with their polarities in wrong direction.

Do not force to bend the arm cuff or the air tube excessively.

When removing the air tube, pull at the plug.

Do not apply strong shock or drop the main unit.

Do not inflate the arm cuff without it being wrapped on the arm.

KNOW YOUR UNIT

Main Unit:

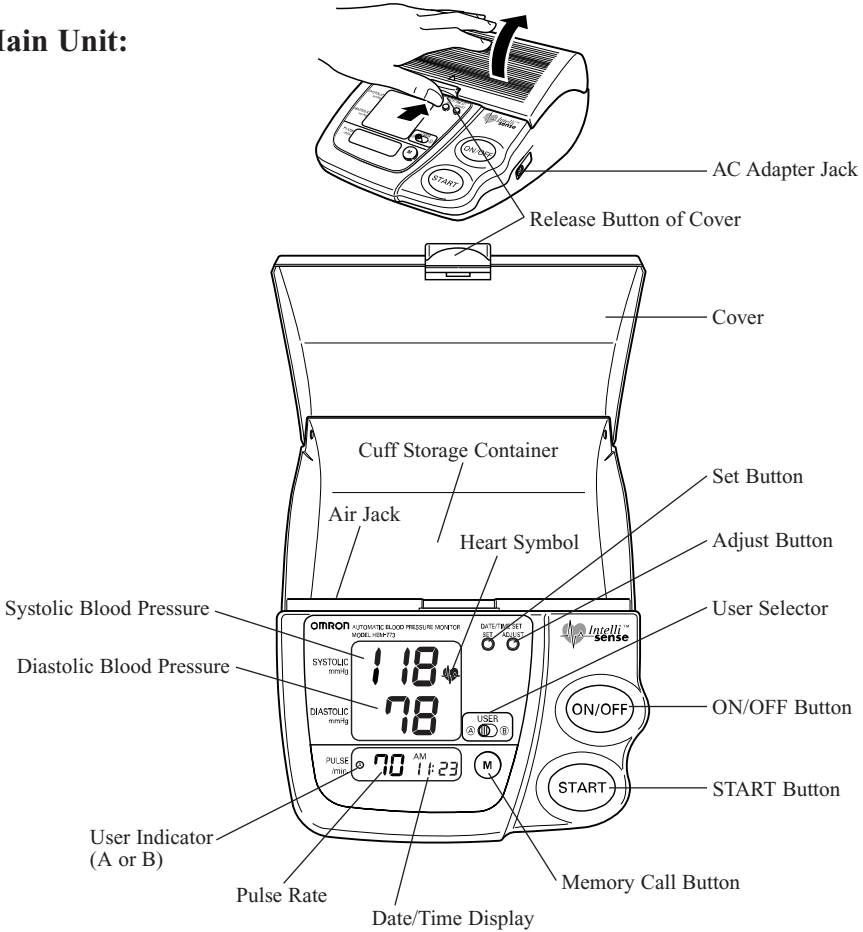

Components:

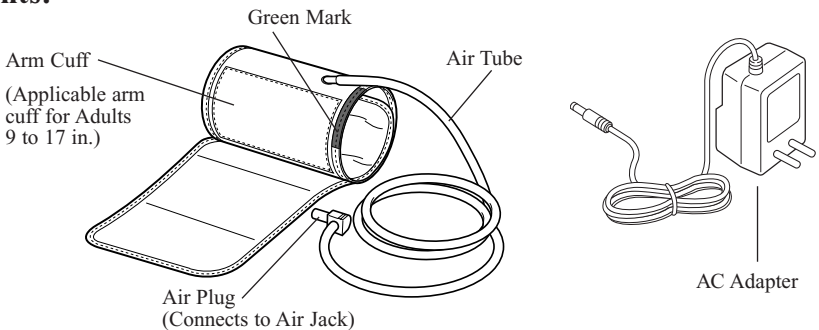

QUICK REFERENCE GUIDE

1. Avoid eating, smoking, and exercising for at least 30 minutes before taking a measurement.
2. Remove tight-fitting clothing from your upper left arm.
3. Sit in a chair with your feet flat on the floor and place your left arm on a table so that the cuff is at the same level as your heart.
4. Wrap the arm cuff around your upper left arm, making sure that the bottom edge of the cuff is approximately 1/2" to 1" above the elbow.

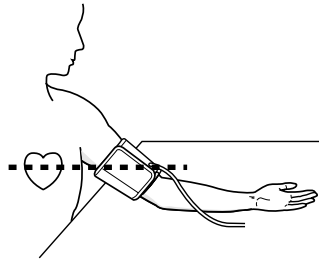
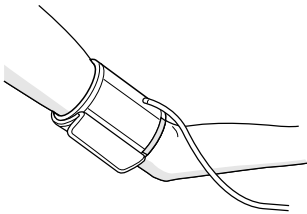

5. Pull the end of the cuff so that the entire cuff is evenly tightened around your arm, and the Green Marker on the cuff is above the brachial artery.
6. Press the ON/OFF button.
7. After the Heart Symbol (♥) appears on the digital panel, press the START button, and remain still until the measurement is complete.
8. When measurement is complete, the monitor displays your blood pressure and pulse rate, and automatically deflates the cuff.
9. Wait 2-3 minutes before taking another blood pressure measurement.
You may require more rest time between readings depending on your individual physiological characteristics.

BATTERY INSTALLATION/REPLACEMENT

1. Slide the battery cover off in the direction of the arrow.

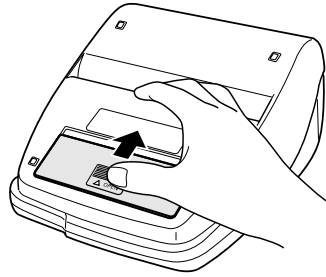

2. Install or replace 4 “AA” size batteries so the + (positive) and – (negative) polarities match the polarities of the battery compartment as indicated.

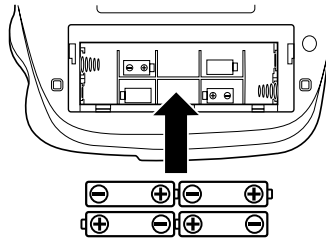

3. Replace the battery cover.

NOTES:

If the Low Battery Indicator () appears on the display, replace all four batteries. Long-life alkaline batteries are recommended.

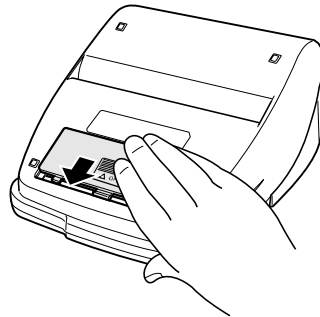

Remove the batteries if the monitor will not be used for an extended period of time.

If the batteries remain removed longer than 30 seconds, the set date and time will be deleted.

HOW TO SET TIME AND DATE

1. When the batteries are installed, the display will show 12:00 a.m.

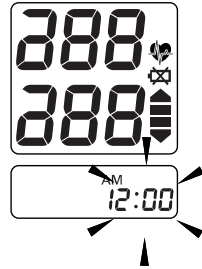

2. Press and hold the SET button.
The year digits (2002) will flash.

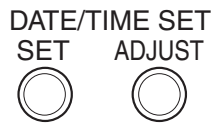

3. Press the ADJUST button to advance the digit(s) one at a time.
If you hold down the ADJUST button, the digits will advance rapidly.

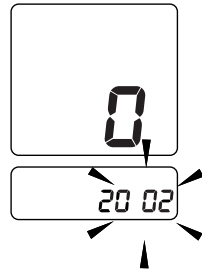

4. Press SET button when desired number is on the display to lock setting.

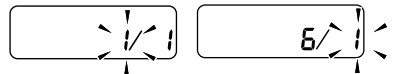

5. Repeat Step 3-4 for month and date.

6. Repeat Step 3-4 for hour and minutes.



HOW TO USE THE AC ADAPTER

To avoid potential damage to the monitor, use only the exclusive Omron AC adapter (HEM-ADPT1).

To connect the AC adapter

1. Insert the AC adapter plug into the AC Adapter jack on the right side of the main unit.
2. Plug in the AC adapter into a 120V AC outlet (50 - 60 cycles).

To remove the AC adapter disconnect the adapter plug from the AC outlet first and then disconnect the cord from the monitor's jack.

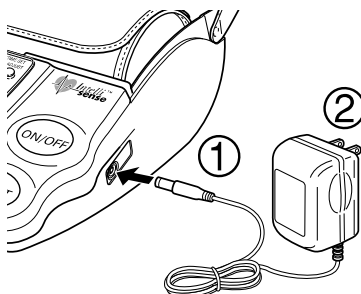

NOTE:

The monitor is designed not to draw power from the batteries when the AC adapter is in use.

HOW TO APPLY THE ARM CUFF

when wrapping
on your left arm

1. Check if the air plug is securely inserted in the main unit.
2. Remove tight-fitting clothing from your upper arm.
3. Sit in a chair with your feet flat on the floor and place your arm on a table so that the cuff will be at same level as your heart.

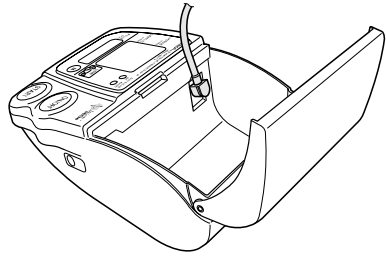

4. Hold the cloth velcro on the cuff with your other hand.

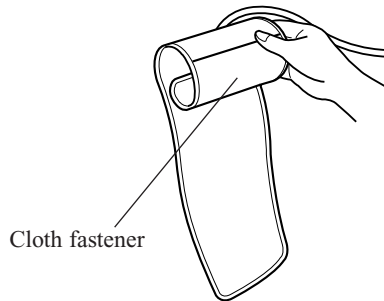

5. Turn the palm of your hand upward. Apply the cuff on your upper arm.

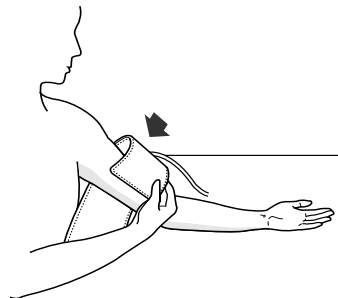

HOW TO APPLY THE ARM CUFF when wrapping on your left arm (Continued)

- Align the Green Marker of the cuff over the brachial artery on the inside of the arm

The bottom of the cuff should be approximately 1/2"-1" above your elbow.

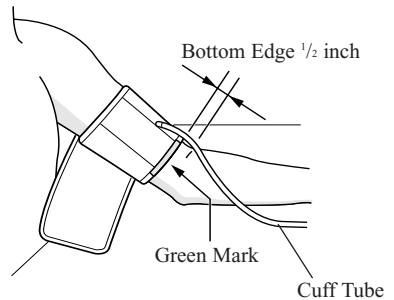

- Secure the cuff around your arm using the cloth velcro.

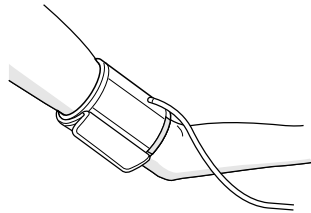

- Make sure the cuff is wrapped firmly in place.

- Relax your arm and put the elbow on the table.

NOTE: Arm cuff can also be wrapped on your right arm. Follow the instructions above (numbers 1-9)

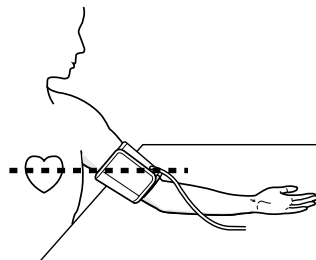

HOW TO TAKE A READING

If you are going to use the unit's memory function to automatically store the measurement values, you need to choose user A or B on the User Selector before starting a measurement.

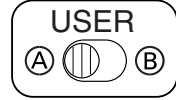

1. Press the ON/OFF button.

- a) All display symbols appear for approximately one second.
- b) When the monitor becomes ready to measure, the Heart Symbol (♥) appears on the display.

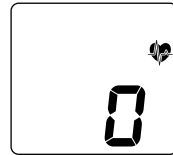

2. Press the START button and remain still.

As the cuff begins to inflate, the monitor automatically determines your ideal inflation level. Because this monitor detects the pulse even during inflation, do not move your arm and remain still until the entire measurement completes.

- If you want to stop the inflation or measurement, press the ON/OFF button. The monitor will stop inflating and start deflating rapidly, and the monitor will turn off.

3. Inflation stops automatically and measurement is started.

As the cuff slowly deflates, decreasing numbers appear on the display and the Heart Symbol (♥) flashes at every heartbeat. In rare circumstances, a higher inflation may be necessary. In those cases, the monitor reinflates the cuff up to 30 mmHg higher than initial inflation and restarts the measurement.

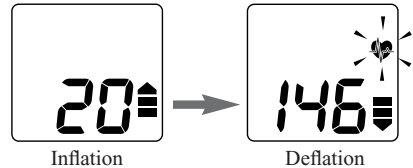

HOW TO TAKE A READING (Continued)

- When the measurement is complete, the arm cuff completely deflates and your blood pressure and pulse rate are displayed.



NOTE:

The monitor automatically stores blood pressure and pulse rate into the memory.

- When 21 sets of readings are stored in memory, the oldest set will be deleted to store a new set.

- Press the ON/OFF button to turn the monitor off.

NOTE:

If you forget to turn the monitor off, it will automatically shut itself off after five minutes.

Instructions for special conditions:

- If your systolic pressure is known to be more than 220 mmHg, press and hold the START button until the monitor inflates 30 to 40 mmHg higher than your suspected systolic pressure.

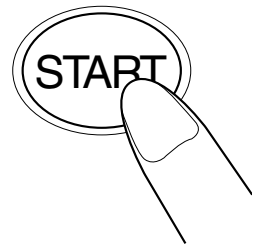

Continue to press button

NOTE:

Do not apply more pressure than necessary.

The monitor will not inflate above 280 mmHg.

HOW TO USE THE MEMORY FUNCTION

This monitor has a memory capable of storing 21 sets of readings each for A and B User Selector. Every time you complete the measurement, the monitor automatically stores blood pressure and pulse rate.

- Select the user to recall memory by the User Selector.
- Turn on the monitor by pressing ON/OFF button.
- Press the (M) button to recall stored readings while the Heart Symbol (♥) is displayed.

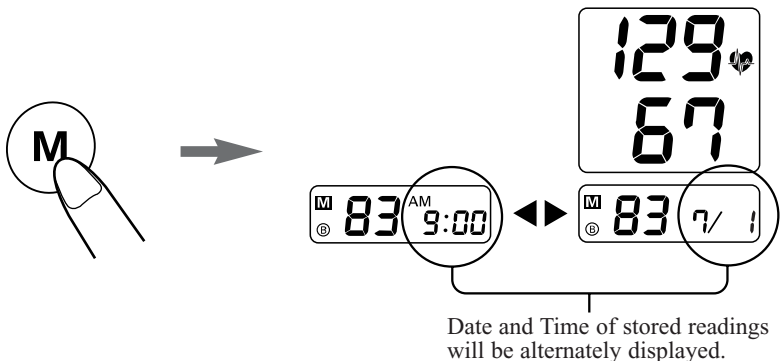

- To delete all the stored readings, press the (M) button and the START button simultaneously.

NOTE: You can not delete the stored readings partially.

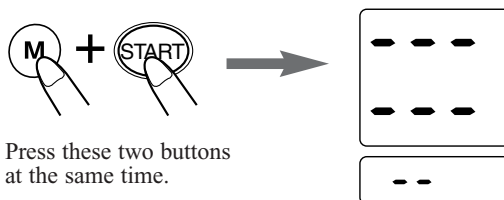

TROUBLESHOOTING

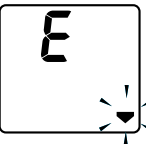
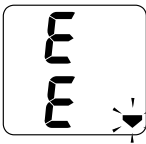
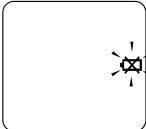
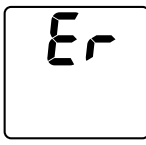
Error Indicator	Cause	Correction
	Cuff under-inflated.	Turn monitor off, wait 2-3 minutes and take another measurement (some users may require a longer waiting period). Repeat steps listed under "How to Take a Reading." If "EE" is displayed again, take another measurement by pressing and holding the START button as shown on instruction page 13 under "Instructions for special conditions."
	Movement during measurement.	Your cuff may be wrapped too tightly around your arm.
	Cuff over-inflated (more than 280 mmHg).	Turn the monitor off, carefully read and repeat steps listed under "How to Take a Reading."
	Battery voltage is excessively low.	Replace all four "AA" batteries with new batteries.
	Problem caused by abnormal memory function.	Contact OMRON HEALTHCARE CUSTOMER SERVICE (toll free 1-800-634-4350).

If you continue to have difficulty obtaining a reading, call **OMRON HEALTHCARE CUSTOMER SERVICE TOLL FREE 1-800-634-4350**. Please tell the representative you have an OMRON Model HEM-773AC.

CAUTION

CAUTION:

Changes or modifications not expressly approved by Omron Healthcare, Inc. could void the user's warranty.

NOTE :

POTENTIAL FOR RADIO/TELEVISION INTERFERENCE (for U.S.A. only)

This product has been tested and found to comply with the limits for a Class B digital device, pursuant to part 15 of the FCC rules. These limits are designed to provide reasonable protection against harmful interference in a residential installation. The product generates, uses, and can radiate radio frequency energy and, if not installed and used in accordance with the instructions, may cause harmful interference to radio communications. However, there is no guarantee that interference will not occur in a particular installation. If the product does cause harmful interference to radio or television reception, which can be determined by turning the product on and off, the user is encouraged to try to correct the interference by one or more of the following measures:

- Reorient or relocate the receiving antenna.
- Increase the separation between the product and receiver.
- Connect the product into an outlet on a circuit different from that to which the receiver is connected.
- Consult the dealer or an experienced radio/TV technician for help.

POTENTIAL FOR RADIO/TELEVISION INTERFERENCE (for Canada only)

This digital apparatus does not exceed the Class B limits for radio noise emissions from digital apparatus as set out in the interference-causing equipment standard entitled "Digital Apparatus", ICES-003 of the Canadian Department of Communications.

CARE AND MAINTENANCE

To keep your digital blood pressure monitor in the best condition and protect the unit from damage follow the directions listed below:

Clean the monitor with a soft dry cloth. Do not use any abrasive or volatile cleaners. Do not attempt to clean the cuff. Never immerse the monitor or any components in water.

Store the monitor in a safe and dry location. Do not subject the monitor to extreme hot or cold temperatures, humidity and direct sunlight. Avoid subjecting the monitor to strong shocks such as dropping on the floor. Remove the batteries if the unit will not be used for an extended period of time.

Use the unit consistent with the instruction provided in this manual. Never inflate the unit over 280 mmHg or attempt to disassemble the monitor. Use only authorized parts and accessories.

WARRANTY

Your HEM-773AC IntelliSense™ Automatic Blood Pressure Monitor is warranted to be free from manufacturing defects for a period of five years under normal use. The five year warranty excludes the arm cuff. **The arm cuff is warranted for a one year period.** This warranty extends only to the original retail purchaser.

Should repair be needed within the warranty period, ship the unit prepaid with the proof of purchase date and \$5.00 for return shipping and insurance to:

Omron Healthcare, Inc.
Attn: Repair Department
300 Lakeview Parkway
Vernon Hills, IL 60061

Be sure to include the model number and your phone number on any correspondence.

We will either repair or replace (at our option) free of charge any parts necessary to correct defects in the materials or workmanship.

The above warranty is complete and exclusive. The warrantor expressly disclaims liability for incidental, special, or consequential damages of any nature. (Some states do not allow the exclusion or limitation of incidental or consequential damages, so the above warranty may not apply to you.)

Any implied warranties arising by the operation of law shall be limited in duration to the term of this warranty. (Some states do not allow limitations on how long an implied warranty lasts, so the above limitation may not apply to you.)

This warranty gives you specific legal rights, and you may have other rights which vary from state to state. As a condition to operation of your warranty, the enclosed registration card must be completed and sent to us within 10 days from the date of purchase.

FOR CUSTOMER SERVICE CONTACT:

By phone toll free
By using the feedback form at

1-800-634-4350
www.omronhealthcare.com

SPECIFICATIONS

Model:	HEM-773AC
Display:	LCD Digital Display
Measurement Range:	Pressure: 0 to 280 mmHg Pulse: 40 to 180/minute
Accuracy/Calibration:	Pressure: ± 3 mmHg Pulse: $\pm 5\%$ of reading
Inflation:	Automatic by electric pump
Deflation:	Active electronic control valve
Rapid Pressure Release:	Active electronic control valve
Pressure Detection:	Capacitive pressure sensor
Measurement Method:	Oscillometric method
Pulse Wave Detection:	Capacitive pressure sensor
Power Source:	4 "AA" batteries or AC adapter
Battery Life:	Approximately 250 uses
Operating Temperatures/Humidity:	50°F to 104°F (10°C to 40°C) 30 to 85% RH maximum
Storage Temperatures/Humidity:	-4°F to 140°F (-20°C to 60°C) 10 to 95% RH maximum
Main Unit Weight:	Approximately 31.8 oz (900g) not including batteries
Main Unit Dimensions:	Approximately 9" (l) x 7" (w) x 4" (h) (228 mm x 178 mm x 102 mm)
Cuff Size:	Approximately 6" (w) (152 mm) Cuff Tube 23 $\frac{5}{8}$ " (l) (600 mm)
Cuff Circumference:	Fits arm circumference 9" to 17" (228 mm to 432 mm)
Components:	Arm cuff, Instruction manual, 4 "AA" Batteries, AC Adapter

NOTE: These specifications are subject to change without notice.

Manufactured by: OMRON

Distributed by:

OMRON HEALTHCARE, INC.

300 Lakeview Parkway

Vernon Hills, Illinois 60061

www.omronhealthcare.com

Copyright © 2003 OMRON HEALTHCARE, INC.

773ACINST Rev A