

OMRON®

Instruction Manual



Wrist Blood Pressure Monitor with Advanced Positioning Sensor (APS®)

Model HEM-650

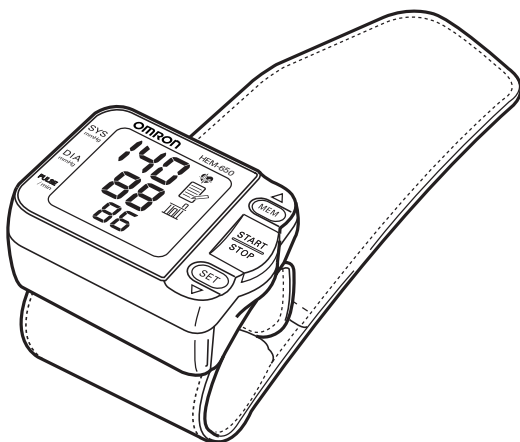

ESPAÑOL



ENGLISH

TABLE OF CONTENTS

Before Using the Monitor

Introduction	3
Safety Information	4
Operating the Device	4
Care and Maintenance	5
Before Taking a Measurement	6

Operating Instructions

Know Your Unit	7
Unit Display	9
Display Symbols	10
Irregular Heartbeat Symbol ()	10
Heartbeat Symbol ()	12
Average Value Symbol ()	12
Battery Installation	13
Setting the Advanced Positioning Sensor	15
Setting the Position Sensor Alarm	16
Setting the Measurement Wrist	17
Setting the Date and Time	18
Applying the Wrist Cuff	21
Taking a Measurement	24
Taking a Measurement on the Left Wrist	24
Taking a Measurement on the Right Wrist	26
Using the Memory Function	27
Averaging Function	27
To Display the Measurement Values	28
To Delete All Values Stored in the Memory	29

Care and Maintenance

Care and Maintenance	30
Error Indicators and Troubleshooting Tips	31
FCC Statement	33
Warranty	34
Specifications	35

INTRODUCTION

Thank you for purchasing the Omron® HEM-650 Wrist Blood Pressure Monitor with Advanced Positioning Sensor (APS®).

Fill in for future reference.

DATE PURCHASED: _____

SERIAL NUMBER: _____

Staple your purchase receipt here

The Omron wrist monitor uses the oscillometric method of blood pressure measurement. This means the monitor detects your blood's movement through the artery in your wrist and converts the movements into a digital reading.

Clinical research has proven a direct relationship between blood pressure in the wrist and blood pressure in the arm. Changes in wrist blood pressure reflect changes in arm blood pressure because the arteries in the arm and wrist connect.

Frequently measuring the blood pressure in your wrist will provide your physician with an accurate indication of changes in your blood pressure.

The HEM-650 comes with the following components:



- Main Unit
- 2 "AAA" Batteries
- Storage Case
- Warranty Card
- Instruction Manual printed in English and Spanish

The Omron HEM-650 Wrist Blood Pressure Monitor is intended for home use.

SAVE THESE INSTRUCTIONS

SAFETY INFORMATION

To assure the correct use of the product basic safety measures should always be followed including the warnings and cautions listed in this instruction manual.

SAFETY SYMBOLS USED IN THIS INSTRUCTION MANUAL	
 WARNING	Indicates a potentially hazardous situation which, if not avoided, could result in death or serious injury.
 CAUTION	Indicates a potentially hazardous situation which, if not avoided, may result in minor or moderate injury to the user or patient or damage to the equipment or other property.

OPERATING THE DEVICE

- ▲ Contact your physician for specific information about your blood pressure. Self-diagnosis and treatment using measured results may be dangerous. Follow the instructions of your physician or licensed healthcare provider.
- ▲ If battery fluid should get in your eyes, immediately rinse with plenty of clean water. Contact a physician immediately.
- ▲ If you have a condition that may compromise circulation, you may get an inaccurate reading with this device. Consult your physician before using this device.
- ▲ Read all of the information in the instruction manual and any other literature in the box before operating the unit.
- ▲ This device is intended for use in measuring blood pressure and pulse rate in the adult population. Do not use this device on infants or persons who cannot express their intentions.

SAFETY INFORMATION

OPERATING THE DEVICE (continued)

- ⚠ Operate the device only as intended. Do not use the device for any other purpose.
- ⚠ Dispose of the device, components and optional accessories according to applicable local regulations. Unlawful disposal may cause environmental pollution.
- ⚠ Do not use a cellular phone near the device. It may result in an operational failure.
- ⚠ Use only Omron authorized parts and accessories. Parts and accessories not approved for use with the device may damage the unit.
- ⚠ Use only 1.5V alkaline batteries with this device. Do not use other types of batteries. This may damage the unit.

CARE AND MAINTENANCE

- ⚠ Do not subject the monitor to strong shocks, such as dropping the unit on the floor.
- ⚠ Do not submerge the device or any of the components in water.
- ⚠ Store the device and the components in a clean, safe location.
- ⚠ Changes or modification not approved by Omron Healthcare will void the user warranty. Do not disassemble or attempt to repair the unit or components.

BEFORE TAKING A MEASUREMENT

To ensure a reliable reading follow these recommendations:

1. Avoid eating, drinking alcohol, smoking, exercising and bathing for at least 30 minutes before taking measurement. Rest for at least 15 minutes before taking a measurement.
2. Stress raises blood pressure. Avoid taking measurements during stressful times.
3. The cuff can be applied to your left or right wrist.
4. Measurements should be taken in a quiet place and you should be in a relaxed, seated position.
5. Remain still and do not talk during the measurements.
6. Keep a record of your blood pressure and pulse for your physician. A single measurement may not provide an accurate indication of your true blood pressure. You need to take and record several readings over a period of time. Try to measure your blood pressure at the same time each day for consistency.
7. Wait 2-3 minutes between measurements. The wait time allows the arteries to return to the condition prior to taking the blood pressure measurement. You may need to increase the wait time depending on your individual physiological characteristics.

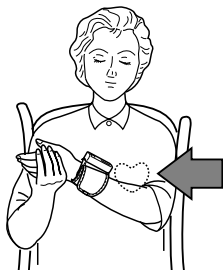

KNOW YOUR UNIT

Main Unit:

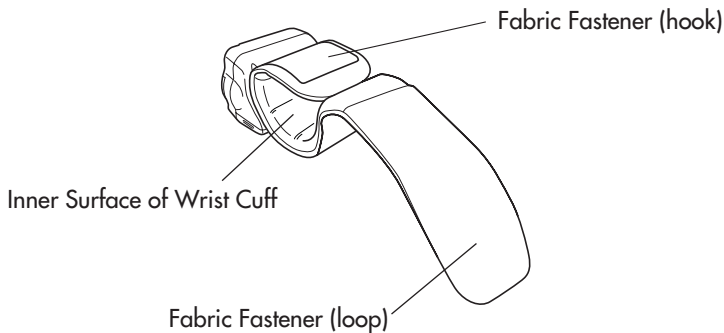
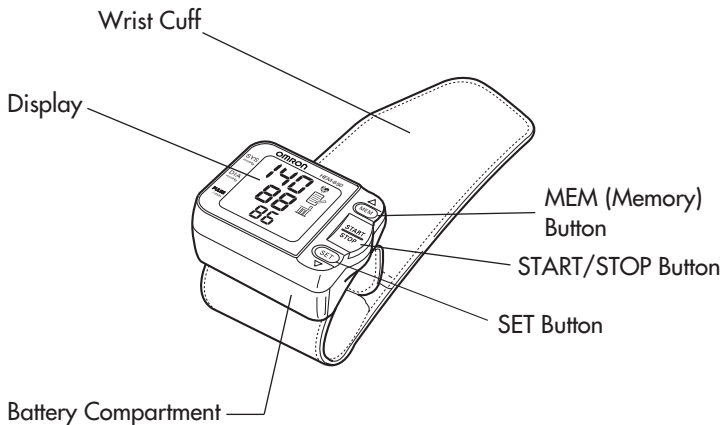

KNOW YOUR UNIT

Components:

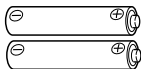

Two "AAA" Batteries

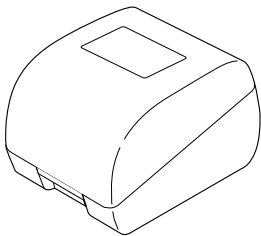

Storage Case



Instruction Manual

INTELLISENSE® TECHNOLOGY IS AN ASSURANCE OF ACCURACY

Blood pressure changes throughout the day. IntelliSense® Technology automatically determines the optimum amount of pressure required to quickly and comfortably measure your blood pressure. This helps to ensure an accurate measurement.

ADVANCED POSITIONING SENSOR (APS®) ENSURES A RELIABLE MEASUREMENT

Correct cuff positioning is critical when monitoring blood pressure. The Omron Wrist Blood Pressure Monitor with APS® has a unique positioning sensor that confirms the cuff is level with the user's heart. This helps ensure that each reading is accurate and reliable.

UNIT DISPLAY

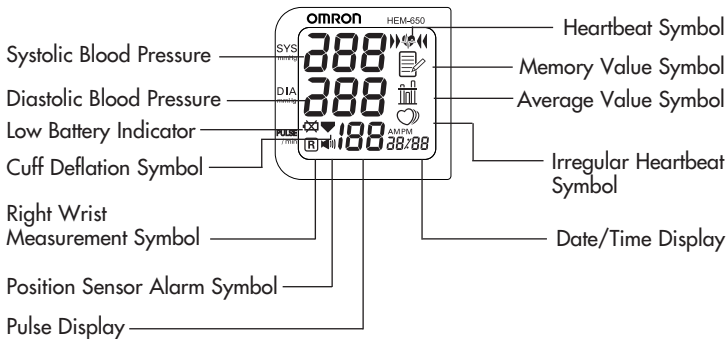

DISPLAY SYMBOLS

IRREGULAR HEARTBEAT SYMBOL (🫀)

When the monitor detects an irregular rhythm two or more times during the measurement, the Irregular Heartbeat Symbol (🫀) will appear on the display with the measurement values.

An irregular heartbeat rhythm is defined as a rhythm that is more than 25% slower or 25% faster from the average rhythm detected while the monitor is measuring the systolic blood pressure and the diastolic blood pressure.

If the irregular heartbeat symbol (🫀) displays with your measurement results, we recommend you consult your physician. Follow the directions of your doctor.

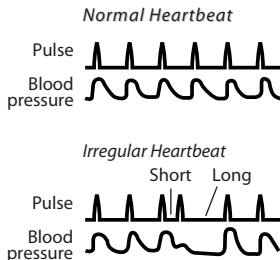

DISPLAY SYMBOLS

The American Heart Association (AHA) recommends the following guideline for upper limit of normal for home blood pressure readings:

AHA Home Guideline for Upper Limit of Normal BP	
Systolic Blood Pressure	135 mmHg
Diastolic Blood Pressure	85 mmHg

This is a general guideline because blood pressure depends on age and morbidity. The AHA recommends a lower home blood pressure goal for certain patients, including diabetic patients, pregnant women, and patients with renal failure¹.

The monitor is not intended to be a diagnostic device.

⚠ WARNING

Contact your physician for specific information about your blood pressure. Self-diagnosis and treatment using measured results may be dangerous. Follow the instructions of your physician or licensed healthcare provider.



Omron Healthcare recommends you contact your physician if the HEARTBEAT SYMBOL () appears on the display with your measurement values. Follow the directions of your doctor.

¹American Heart Association Scientific Statement 2004

DISPLAY SYMBOLS

HEARTBEAT SYMBOL ()

TAKING A MEASUREMENT

The Heartbeat Symbol () flashes on the display during the measurement. The Heartbeat Symbol () flashes at every heartbeat.

When the measurement is complete, the Heartbeat Symbol () flashes on the display with your blood pressure and pulse rate if the reading is above 135 for the Systolic Blood Pressure value and/or 85 for the Diastolic Blood Pressure value.

USING THE MEMORY FUNCTION

The Heartbeat Symbol () flashes when the blood pressure reading stored in the memory is above 135 for the Systolic Blood Pressure value and/or 85 for the Diastolic Blood Pressure value.

AVERAGE VALUE SYMBOL ()

The Average Value Symbol () is displayed when you press the MEM button. The most recent average reading appears on the display screen.

BATTERY INSTALLATION

1. Press both sides of the battery cover and lift the cover off in the direction of the arrow.

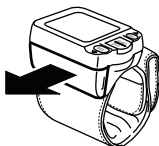

2. Install 2 “AAA” Alkaline Batteries so the + (positive) and - (negative) polarities match the polarities of the battery compartment as indicated.

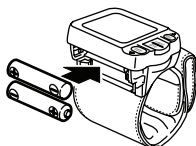

3. Replace the Battery Cover. Make sure the cover clicks securely over the battery compartment.

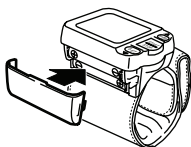

BATTERY INSTALLATION

BATTERY REPLACEMENT



Low Battery Indicator

When the Low Battery Indicator appears on the display screen turn the monitor off and remove all the batteries. Replace with two new batteries at the same time.

▲ WARNING

If battery fluid should get in your eyes, immediately rinse with plenty of clean water. Contact a physician immediately.

- NOTES:**
- Turn the unit off before replacing the batteries. Measurement values stored in the memory are not deleted during battery replacement.
 - When the batteries are replaced, you may need to reset the date and time. If the year is flashing on the display screen, refer to “Setting the Date and Time”.
 - The supplied batteries may have a shorter life.

▲ CAUTION

Dispose of the device, components and optional accessories according to applicable local regulations. Unlawful disposal may cause environmental pollution.

SETTING THE ADVANCED POSITIONING SENSOR

The Advanced Positioning Sensor (APS®) will assure you the unit is in the correct position level with the user's heart before the monitor starts to take the measurement. When the APS is set to ON, the Heartbeat Symbol (♥) flashes once your wrist is in the correct position. The APS is set to ON at the time of purchase.

1. TO CHANGE THE SETTING

Press the START/STOP button to turn the power off, then press the SET button.

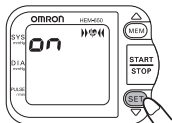

The Position Sensor symbol (♥) will appear on the display.

2. SELECTING ON OR OFF

Press the MEM button to change the setting to OFF.

Press the MEM button again to change the setting to ON.

3. CONFIRM THE SETTING

Press the START/STOP button to confirm the APS function you selected and to turn the monitor off.

SETTING THE POSITION SENSOR ALARM

The Position Sensor Alarm emits sound to help you place your wrist in the correct position. The Position Sensor Alarm can be set to ON or OFF when the APS is set to ON. The Position Sensor Alarm is set to ON1 at the time of purchase.

The alarm set to “ON1” emits a series of blips when your wrist is too far away from the correct measuring position and beeps slowly once your wrist is in the correct position.

The alarm set to “ON2” beeps only once your wrist is in the correct position.

1. TO CHANGE THE SETTING

Press the START/STOP button to turn the power off, then press the SET button twice.

The Position Sensor Alarm symbol () will appear on the display.



2. SELECTING ON1, ON2, OR OFF

Press the MEM button to change the setting to “ON2”, “OFF” and “ON1”.

3. CONFIRM THE SETTING

Press the START/STOP button to confirm the alarm function you selected and to turn the monitor off.

SETTING THE MEASUREMENT WRIST

The monitor is designed to take measurements on the left wrist or the right wrist. The monitor is set to OFF to take measurements on the left wrist at the time of purchase.

1. TO CHANGE THE SETTING

Press the START/STOP button to turn the power off, then press the SET button three (3) times.

The Right Wrist Measurement symbol (**R**) will appear on the display.

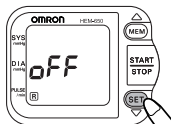

2. SELECTING ON OR OFF

Press the MEM button to change the wrist setting to ON to take measurements on the right wrist.

Press the MEM button again to change the wrist setting to OFF to take measurements on the left wrist.

3. CONFIRM THE SETTING

Press the START/STOP button to confirm the measurement wrist you selected and to turn the monitor off.

SETTING THE DATE AND TIME

Set the monitor to the current date and time before taking a measurement for the first time. If the date and time are not set correctly, the measurement values stored in the memory will have the wrong date and time.

Set the date and time in the following situations:

1. Before you use the monitor for the first time
2. After battery replacement

1. TO CHANGE THE SETTING

Press the START/STOP button to turn the power off, then press the SET button four (4) times.

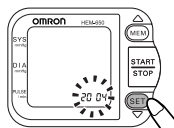

The year flashes on the display with the current setting.

2. SETTING THE YEAR

The year can be set between 2004 and 2030.

When the display reaches 2030, it will return to 2004.

Press the MEM button to advance by increments of one year.

NOTE: Press and hold the MEM button to increase the values faster.

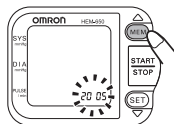

SETTING THE DATE AND TIME

Press the SET button to confirm the setting.
The month flashes on the display.

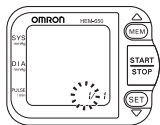

3. SETTING THE MONTH

Press the MEM button to advance by increments of one month.

Press the SET button to confirm the setting.
The day flashes on the display.

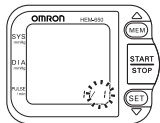

4. SETTING THE DAY

Press the MEM button to advance by increments of one day.

Press the SET button to confirm the setting.
The hour flashes on the display.

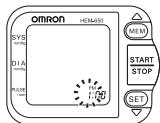

5. SETTING THE HOUR

The time is set using AM or PM.

Press the MEM button to advance by increments of one hour.

Press the SET button to confirm the setting.
The minute flashes on the display.

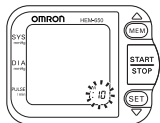

SETTING THE DATE AND TIME

6. SETTING THE MINUTE

Press the MEM button to advance by increments of one minute.

Press the SET button to confirm the setting.

The APS setting screen is displayed.

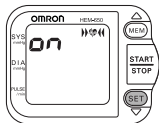

Press the START/STOP button to turn the monitor off.

APPLYING THE WRIST CUFF

The monitor is designed to take measurements on the left wrist or the right wrist. The monitor is set to take measurements on the left wrist at the time of purchase. To change the setting, refer to “Setting the Measurement Wrist”.

⚠ CAUTION

Read all of the information in the instruction manual and any other literature in the box before operating the unit.

⚠ CAUTION

This device is intended for use in measuring blood pressure and pulse rate in the adult population. Do not use this device on infants or persons who cannot express their intentions.

APPLYING THE WRIST CUFF

APPLYING THE WRIST CUFF ON THE LEFT WRIST

1. Roll up sleeve. Make sure your sleeve is not rolled up too tight on your arm. This may constrict the flow of blood in your arm.

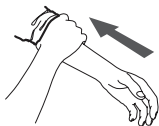

2. Wrap the cuff directly against your skin. Do not apply over clothing. Place the cuff over your left wrist with your left thumb facing upward.
3. Position the cuff leaving a clearance of approximately 1/2 to 1 inch between the cuff and the bottom of your palm.

4. Hold the bottom part of the cuff and wrap it around the wrist so it fits comfortably and securely around your wrist.



5. Fold the remaining part of the wrist cuff back out of the way. Lightly press the cloth closure with your finger so the cuff is securely fastened.



APPLYING THE WRIST CUFF

NOTES:

- If the cuff is not securely fastened, the wrist cuff may become loose during measurement and the measurement may not be possible.
- Users with a wrist circumference of less than 5 3/4 inches may feel the wrist cuff move if the cloth fastener is not wrapped snugly. In this case, do not wrap the wrist cuff any tighter, it will not affect the measurement.
- Fold and fasten the extra portion of wrist cuff as shown to the right. If the extra portion of wrist cuff is not fastened, it will not affect the measurement.



APPLYING THE WRIST CUFF ON THE RIGHT WRIST

When taking a measurement using the right wrist, position the cuff as shown in the illustration. Make sure that the monitor is set to take measurements on the right wrist. To change the setting, refer to “Setting the Measurement Wrist”.

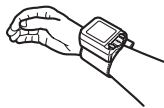

TAKING A MEASUREMENT

⚠ CAUTION

Operate the device only as intended. Do not use the device for any other purpose.

⚠ CAUTION

Do not use a cellular phone near the device. It may result in an operational failure.

TAKING A MEASUREMENT ON THE LEFT WRIST

The APS is set to ON, the Position Sensor Alarm is set to ON1 and the measurement wrist is set to OFF for the left wrist measurement.

Sit comfortably in a chair with your feet flat on the floor.



1. Press the START/STOP button.

Hold your elbow firmly to avoid body movement. Remain still and do not talk or move during the measurement.



2. Adjust the height of your wrist holding your elbow steady until your wrist comes to the level of your heart.

When your wrist reaches the level of your heart, the monitor beeps four long tones and the Heartbeat Symbol (♥) starts to flash. Then the wrist cuff automatically starts to inflate.

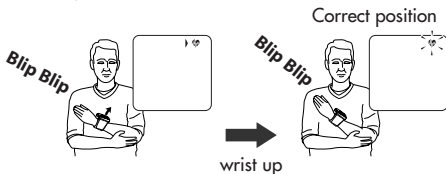

TAKING A MEASUREMENT

Hold your wrist in this position. Do not move until the measurement is complete.

NOTE: To stop the inflation or measurement, press the START/STOP button. The monitor will stop inflating, start deflating and will turn off.

Please be careful not to raise your wrist too high.

If your wrist is raised higher than the level of your heart, the monitor will emit a series of two short blips.

Slowly lower your wrist until the monitor beeps four long tones and the Heartbeat Symbol (♥) starts to flash. Then the wrist cuff automatically starts to inflate.

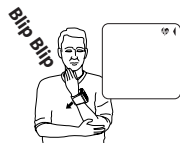

TAKING A MEASUREMENT

3. When the measurement finishes, the deflation symbol (▼) flashes and the wrist cuff deflates.

Your blood pressure and pulse rate are displayed.



Alternating Display

NOTE: The time and date of the measurement are displayed alternately.

The Heartbeat Symbol (♥) flashes on the display with your blood pressure and pulse rate if the reading is above 135 for the Systolic Blood Pressure value and/or 85 for the Diastolic Blood Pressure value.

4. Press the START/STOP button to turn the monitor off.

NOTE: The monitor will automatically turn off after 2 minutes.

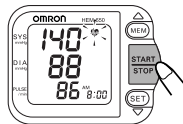

TAKING A MEASUREMENT ON THE RIGHT WRIST

Make sure that the right wrist measurement symbol (R) is displayed once START/STOP button is pressed.

To change the setting, refer to “Setting the Measurement Wrist”.

USING THE MEMORY FUNCTION

The monitor automatically stores up to 90 sets of measurement values with date and time in the memory. When 90 sets of measurement values are stored, the oldest record is deleted to save the most recent values.

AVERAGING FUNCTION

The monitor calculates the average reading based on the three most recent sets of measurement values taken within 10 minutes of the most recent reading.

NOTE: If only two sets of measurement values are stored in the memory for the 10 minute period, the average is based on the two sets of measurement values. If only one set of measurement values is stored, this is displayed as the average.

USING THE MEMORY FUNCTION

TO DISPLAY THE MEASUREMENT VALUES

1. Press the MEM button to display the average reading based on the three most recent sets of measurement values taken within 10 minutes of the most recent reading. The Average Value Symbol () appears on the display when the average reading is shown.

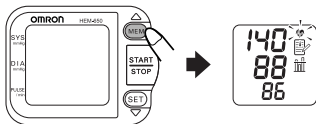

2. Press the MEM button to display the set of measurement values from the most recent to the oldest. Press the SET button to display the next set of measurement values from the oldest to the most recent.

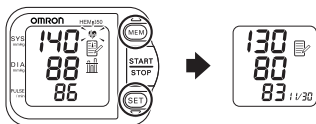

NOTES:

- Press the MEM button or the SET button repeatedly to display the next values.
- Press and hold the MEM button or the SET button to display the values faster.

The date and time are alternately displayed with the measurement values. The Heartbeat Symbol () flashes on the display when the blood pressure reading stored in the memory is above 135 for the Systolic Blood Pressure value and/or 85 for the Diastolic Blood Pressure value.

3. Press the START/STOP button to turn the monitor off.

USING THE MEMORY FUNCTION

TO DELETE ALL VALUES STORED IN THE MEMORY

You cannot partially delete records stored in the memory.

All records will be deleted.

1. While holding down the MEM button, press and hold the START/STOP button for more than 2 seconds.

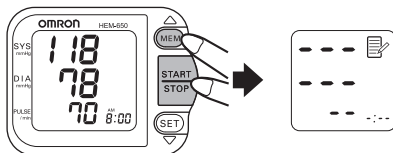

2. Press the START/STOP button to turn the monitor off.

CARE AND MAINTENANCE

To keep your digital blood pressure monitor in the best condition and protect the unit from damage, follow the directions listed below:

Keep the monitor in the storage case when not in use.

Do not fold the wrist cuff too tightly.

The fabric fastener could touch the inner surface of the cuff and damage it.

Clean the monitor with a soft dry cloth. Do not use any abrasive or volatile cleaners. Do not attempt to clean the cuff.

⚠ CAUTION

Do not submerge the device or any of the components in water. Do not subject the monitor to extreme hot or cold temperatures, humidity or direct sunlight.

⚠ CAUTION

Store the device and the components in a clean, safe location.

⚠ CAUTION

Do not subject the monitor to strong shocks, such as dropping the unit on the floor.

Remove the batteries if the unit will not be used for three months or longer. Always replace all the batteries with new ones at the same time.

⚠ CAUTION



Use only Omron authorized parts and accessories. Parts and accessories not approved for use with the device may damage the unit.

⚠ CAUTION



Changes or modification not approved by Omron Healthcare will void the user warranty. Do not disassemble or attempt to repair the unit or components.

ERROR INDICATORS AND TROUBLESHOOTING TIPS

ERROR INDICATORS

SYMBOLS	CAUSE	CORRECTION
 <p>After several seconds</p>	<p>Movement during measurement.</p>	<p>Turn the unit off. Refer to “Taking a Measurement”.</p> <p>Wait 2-3 minutes.</p> <p>Take another measurement and do not move until the measurement results display.</p>
 <p>The Position Sensor Symbol (»«) appears.</p>	<p>Wrist is not in the correct position.</p>	<p>Remove the monitor from your wrist. Refer to “Applying the Wrist Cuff”.</p> <p>Wait 2-3 minutes.</p> <p>Take another measurement.</p>
 <p>Low Battery Indicator appears.</p>	<p>Batteries are worn.</p>	<p>Replace both batteries with new ones immediately.</p>

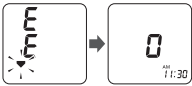
ERROR INDICATORS AND TROUBLESHOOTING TIPS

SYMBOLS	CAUSE	CORRECTION
 <p>After several seconds</p>	Cuff over-inflated.	Repair service required. Refer to “Warranty”.
 <p>Only E and numerals are displayed.</p>	Abnormal unit function.	Repair service required. Refer to “Warranty”.

TROUBLESHOOTING TIPS

PROBLEMS	CAUSE
No display appears on the unit when the START/STOP button is pressed.	Replace all batteries with new ones. Check the battery installation for proper placement of the battery polarities.
Measurement values appear too high or too low.	Blood pressure reading varies constantly. Many factors including stress, time of day, and how you apply the cuff, may affect your blood pressure reading. Review the sections “Before Taking a Measurement”, “Applying the Wrist Cuff” and “Taking a Measurement”.

FCC STATEMENT

NOTE:**POTENTIAL FOR RADIO/TELEVISION INTERFERENCE (for U.S.A. only)**

This product has been tested and found to comply with the limits for a Class B digital device, pursuant to part 15 of the FCC rules.

These limits are designed to provide reasonable protection against harmful interference in a residential installation. The product generates, uses, and can radiate radio frequency energy and, if not installed and used in accordance with the instructions, may cause harmful interference to radio communications. However, there is no guarantee that interference will not occur in a particular installation. If the product does cause harmful interference to radio or television reception, which can be determined by turning the product on and off, the user is encouraged to try to correct the interference by one or more of the following measures:

- Reorient or relocate the receiving antenna.
- Increase the separation between the product and the receiver.
- Connect the product into an outlet on a circuit different from that to which the receiver is connected.
- Consult the dealer or an experienced radio/TV technician for help.

POTENTIAL FOR RADIO/TELEVISION INTERFERENCE (for Canada only)

This digital apparatus does not exceed the Class B limits for radio noise emissions from digital apparatus as set out in the interference-causing equipment standard entitled “Digital Apparatus”, ICES-003 of the Canadian Department of Communications.

Cet appareil numérique respecte les limites de bruits radioélectriques applicables aux appareils numériques de Classe B prescrites dans la norme sur le matériel brouilleur: “Appareils Numériques”, ICES-003 édictée par le ministre des communications.

Changes or modifications not expressly approved by the party responsible for compliance could void the user’s authority to operate the equipment.

WARRANTY

The Omron® HEM-650 Wrist Blood Pressure Monitor with Advanced Positioning Sensor (APS®), excluding the monitor cuff, is warranted to be free from defects in materials and workmanship appearing within 5 years from the date of purchase, when used in accordance with the instructions provided with the monitor. The monitor cuff is warranted to be free from defects in materials and workmanship appearing within one year from the date of purchase when the monitor is used in accordance with the instructions provided with the monitor. The above warranties extend only to the original retail purchaser.

We will, at our option, repair or replace without charge any monitor or monitor cuff covered by the above warranties. Repair or replacement is our only responsibility and your only remedy under the above warranties.

To obtain warranty service contact Omron Healthcare for the address of the repair location. Shipping instructions and repair information is available by calling **1-800-634-4350** or visit our website at www.omronhealthcare.com.

Enclose the Proof of Purchase. Include \$5.00 for the return shipping and handling. Include a letter, with your name, address, phone number, and description of the specific problem. Pack the product carefully to prevent damage in transit. Because of possible loss in transit, we recommend insuring the product with return receipt requested.

ALL IMPLIED WARRANTIES, INCLUDING BUT NOT LIMITED TO THE IMPLIED WARRANTIES OF MERCHANTABILITY AND FITNESS FOR PARTICULAR PURPOSE, ARE LIMITED TO THE DURATION OF THE APPLICABLE WRITTEN WARRANTY ABOVE. Some states do not allow limitations on how long an implied warranty lasts, so the above limitation may not apply to you.

OMRON SHALL NOT BE LIABLE FOR LOSS OF USE OR ANY OTHER INCIDENTAL, CONSEQUENTIAL OR INDIRECT COSTS, EXPENSES OR DAMAGES. Some states do not allow the exclusion or limitation of incidental or consequential damages, so the above exclusions may not apply to you.

This warranty gives you specific legal rights, and you may also have other rights which may vary from state to state.

FOR CUSTOMER SERVICE

Visit our web site at:

www.omronhealthcare.com

Call toll free:

1-800-634-4350

SPECIFICATIONS

Model:	HEM-650
Display:	Digital Display
Measurement Range:	Pressure: 0 to 299 mmHg, Pulse: 40-180/min.
Accuracy/Calibration:	Pressure: ± 3 mmHg or 2% of reading Pulse: $\pm 5\%$ of reading
Inflation:	Automatic by electric pump
Deflation:	Automatic rapid deflation pressure
Rapid Air Release:	Automatic exhaust valve
Pressure Detection:	Electrostatic capacity semi-conductor pressure sensor
Measurement Method:	Oscillometric method
Pulse Wave Detection:	Capacitance type pressure sensor
Power Source:	2 "AAA" batteries (1.5V Alkaline)
Battery Life:	Approximately 300 uses when used 3 times a day with new alkaline batteries when inflated to 170 mmHg at 73°F (23°C).
Operating Temperature /Humidity:	50°F to 104°F (10°C to 40°C) /30 to 85% RH
Storage Temperature /Humidity/Air Pressure:	-4°F to 140°F (-20°C to 60°C) /10 to 95% RH /700 - 1060 hPa
Main Unit Weight:	Approximately 3 7/8 oz (110g) (not including batteries)
Main Unit Dimensions:	2 3/4" (W) x 2 1/8" (H) x 1 7/16" (D) (70 mm x 54 mm x 37 mm) (not including the wrist cuff)
Measurable Circumference of Wrist :	Approximately 5 1/4" to 8 1/2" (Approximately 135 mm to 215 mm)
Memory:	Up to 90
Electric Shock Protection :	Internal power supply appliance type B
Contents:	Main Unit, Two "AAA" Alkaline Batteries, Storage Case, Instruction Manual, Warranty Card.
UPC Code:	0 73796 65036 0

NOTE: These specifications are subject to change without notice.

Manufactured by OMRON HEALTHCARE

Made in China

Distributed by:

OMRON HEALTHCARE, INC.

1200 Lakeside Drive

Bannockburn, Illinois 60015

www.omronhealthcare.com

Copyright © 2007 Omron Healthcare, Inc.