

# OMRON®

## INSTRUCTION MANUAL



### Automatic Blood Pressure Monitor and Print-Out with IntelliSense™

Model **HEM-705CP**





# TABLE OF CONTENTS

Introduction.....	4
Notes on Safety.....	5
Know Your Unit .....	6
Quick Reference Guide .....	7
Initial Set-Up .....	8
Battery Installation/Replacement.....	8
How to Set Time and Date .....	9
How to Connect Printer-Unit.....	10
How to Load Printer Paper .....	11
How to Use the Optional AC adapter .....	12
Correct Usage .....	13
How to Apply Arm Cuff.....	13, 14
How to Take a Reading .....	15, 16
How to Use the Memory Function .....	17
How to Use the Printer-Unit.....	18, 19, 20
Troubleshooting .....	21, 22
Caution.....	23
Care and Maintenance .....	24
Warranty.....	25
Specifications.....	26, 27

# INTRODUCTION

Thank you for purchasing the Omron Automatic Blood Pressure Monitor and Print-Out with IntelliSense™, HEM-705CP. Although your blood pressure fluctuates throughout the day, no self-adjustment is necessary as the monitor intelligently adjusts to your changing conditions. The IntelliSense™ monitor uses fuzzy logic intelligence to sense both your systolic and diastolic blood pressure values, and the result is personalized inflation with every reading. Arm discomfort and misreading due to improper cuff inflation are virtually eliminated.

Your new OMRON monitor uses the oscillometric method of blood pressure measurement. This means the monitor detects your blood's movement through your brachial artery and converts the movements into a digital reading. At the push of a button, the monitor automatically fills the cuff with air, starts deflation, then displays your systolic, diastolic, and pulse readings on an extra large display panel.

**Please read this instruction manual thoroughly before using this unit. For specific information on your own blood pressure, CONTACT YOUR PHYSICIAN.**

# NOTES ON SAFETY



- The warning signs and the sample icons shown here are listed for you to use the product safely and correctly as well as to prevent the risk and the damage to you and others from happening.
- The icons and meanings are as follow.

Warning sign	Contents
 <b>Caution</b>	Indicates matters in which bodily harm or material damage* may arise as a result of incorrect handling.



\* Material damage refers to a wide range of damage involving your house, household goods, domestic animals, and pets.

## Examples of signs



The  icon indicates prohibitions (what you cannot do). Matters involving actual prohibitions are indicated by text or pictures in or near .



The  icon indicates something compulsory (always follow). Matters involving actual compulsory actions are indicated by text or pictures in or near . The left icon refers to "general compulsion".

## Caution

Self-diagnosis of measured results and treatment are dangerous. Please follow the instructions of your doctor.



Do not use the unit on infants or persons who cannot express one's intention.  
Do not use the unit for any purpose other than measuring blood pressure.  
Do not use a cellular phone near the unit.  
Improper operation may result.



Do not disassemble, repair, or remodel the main unit or the arm cuff of the blood pressure monitor.



The battery liquid may leak and damage the main unit. Please observe the following points.

- When you are not going to use the unit for a long period of time (approximately three months or more), take out the batteries.
- Replace the worn batteries with new ones immediately.
- Do not use worn and new batteries together.
- Do not insert the batteries with their polarities in wrong direction.

Do not force to bend the arm cuff or the air tube excessively.

When removing the air tube, pull at the connector.

Do not apply strong shock or drop the main unit.

Do not inflate the arm cuff without it being wrapped on the arm.

# KNOW YOUR UNIT

## Main Unit:

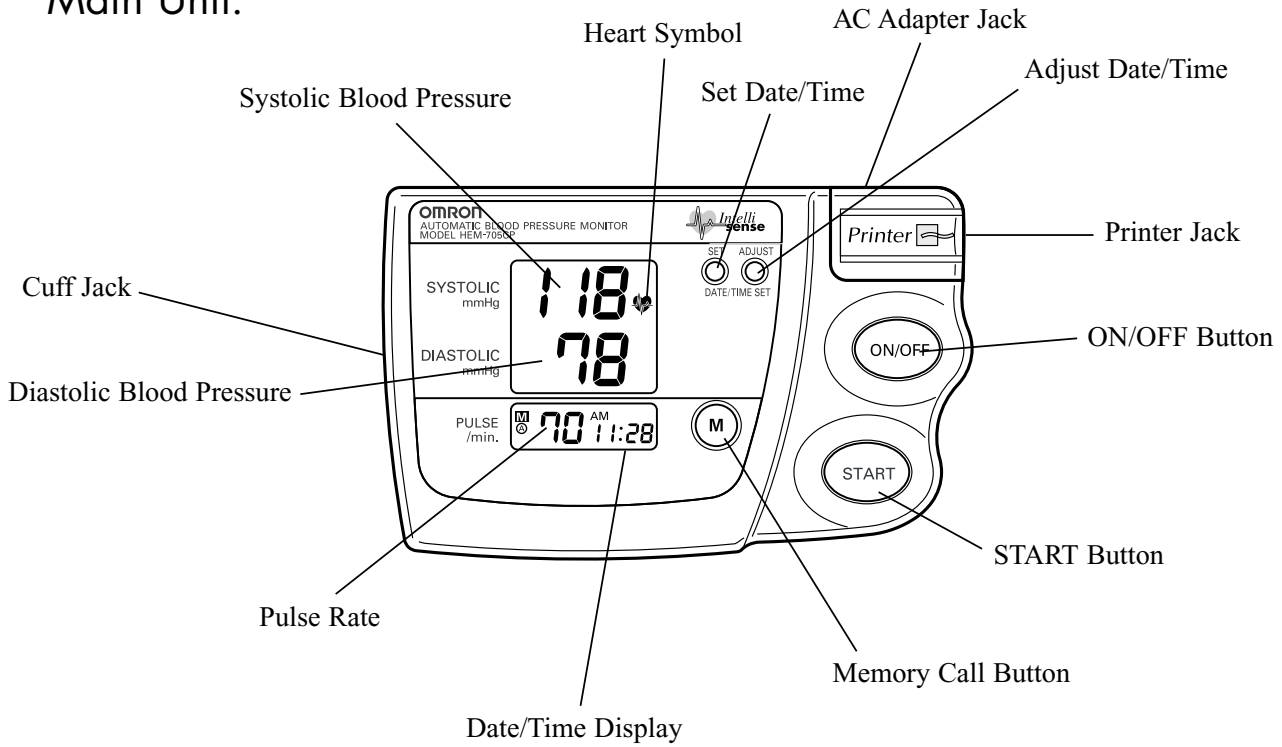

## Printer-Unit:

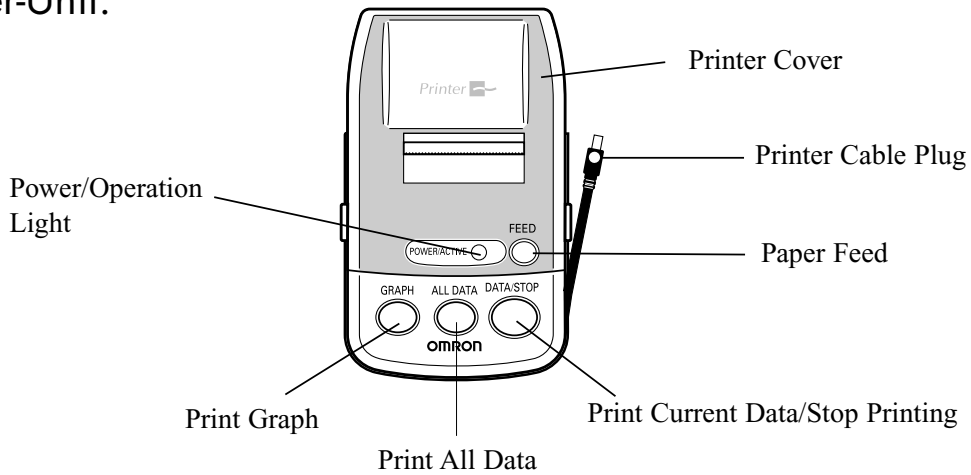

## Accessories:

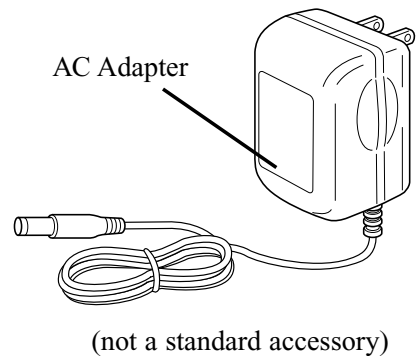
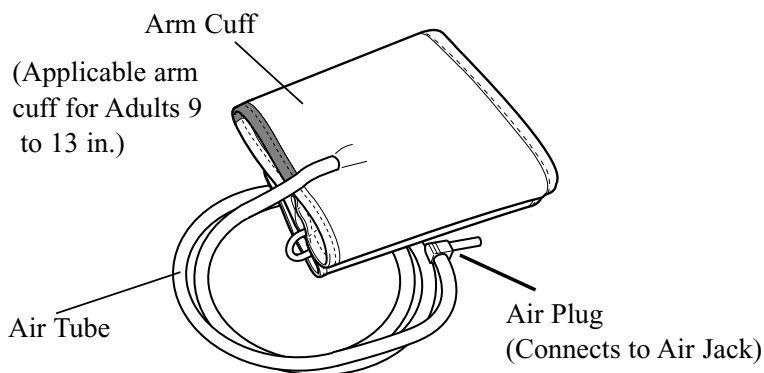

# QUICK REFERENCE GUIDE

1. Avoid eating, smoking, and exercising for at least 30 minutes before taking a measurement.
2. Remove tight-fitting clothing from your upper arm.
3. Sit in a chair with your feet flat on the floor and place your arm on a table so that the cuff is at the same level as your heart.
4. Put your arm through the cuff loop making sure that the bottom edge of the cuff is approximately one-half inch above the elbow and that the Green Marker on the cuff is above brachial artery.

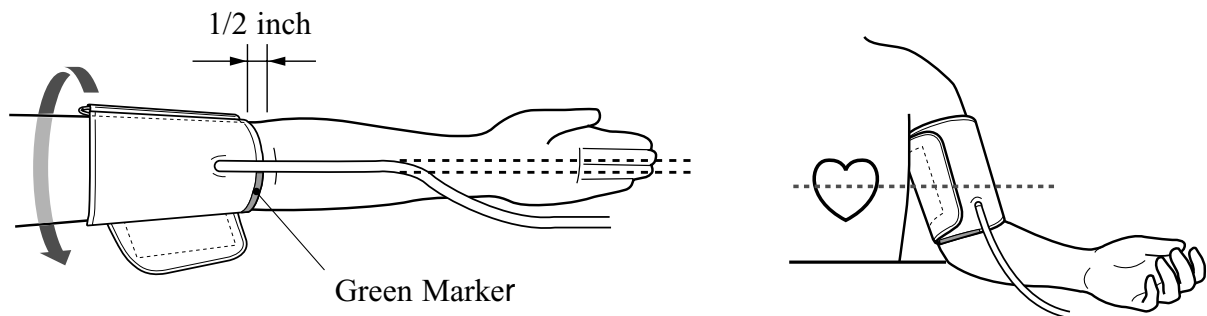

5. Pull the end of the cuff so that the entire cuff is evenly tightened around your arm and press the hook material firmly against the pile side of the cuff.
6. Press the ON/OFF button.
7. After the Heart Symbol (♥) appears on the digital panel, press the Start button, and remain still until the measurement is complete.
8. When measurement is complete, the monitor displays your blood pressure and pulse rate, and automatically deflates the cuff.
9. Wait 2-3 minutes before taking another blood pressure measurement.  
**You may require more rest time between readings depending on your individual physiological characteristics.**

# BATTERY INSTALLATION/REPLACEMENT

1. Slide the battery cover off in the direction of the arrow.

Main Unit:

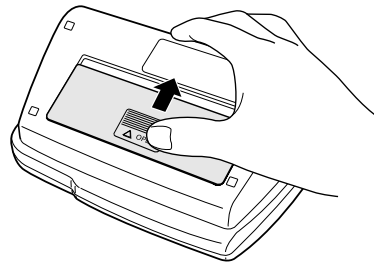

2. Install or replace 4 "AA" size batteries so the + (positive) and - (negative) polarities match the polarities of the battery compartment as indicated.

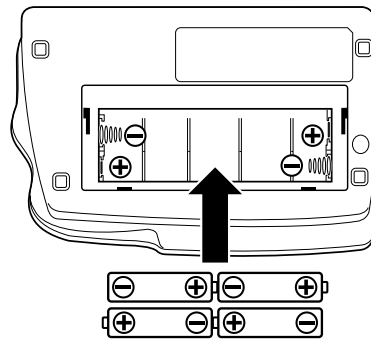

3. Replace the battery cover.

## Notes:

If the Low Battery Indicator (  ) appears on the display, replace all four batteries. Long-life alkaline batteries are recommended.

Remove the batteries if the monitor will not be used for an extended period of time.

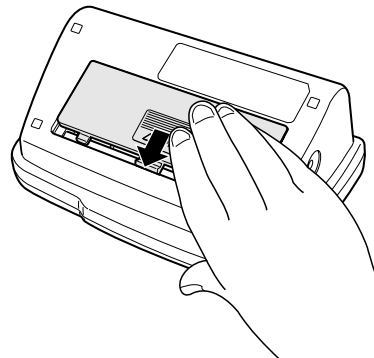

Printer Unit:

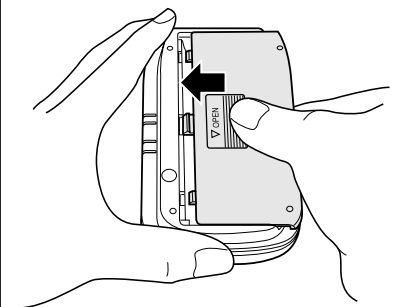
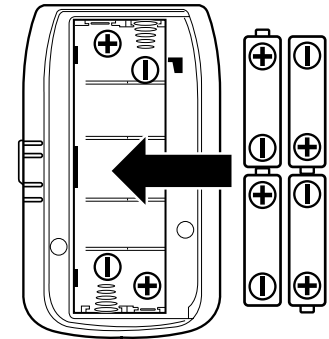
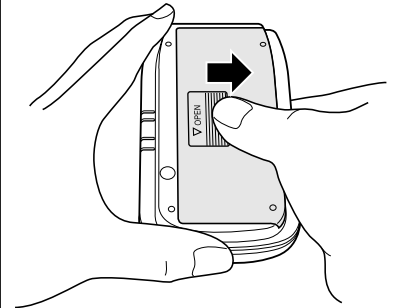



# HOW TO SET TIME AND DATE

1. When the batteries are installed, the display will show 12:00a.m.

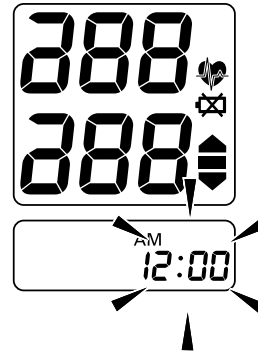

2. Press and hold the “SET” button. The year digits (2001) will flash.

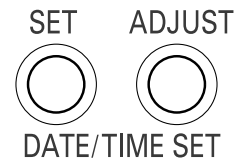

3. Press the “ADJUST” button to advance the digit(s) one at a time. If you hold down the “ADJUST” button, the digits will advance rapidly.

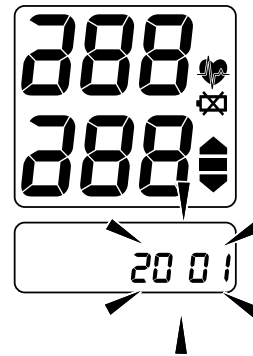

4. Press “SET” button when desired number is on the display to lock setting.

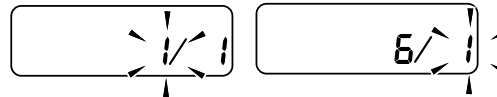

5. Repeat Step 3-4 for month and date.

6. Repeat Step 3-4 for hour and minutes.

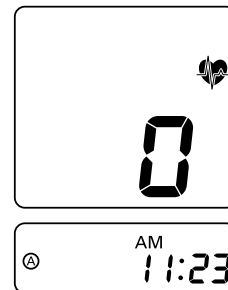

# HOW TO CONNECT PRINTER UNIT

1. Remove printer cable plug from around printer unit.



2. Connect printer cable plug cord to the main unit. Arrow (↔) on printer cable plug should face down to main unit.

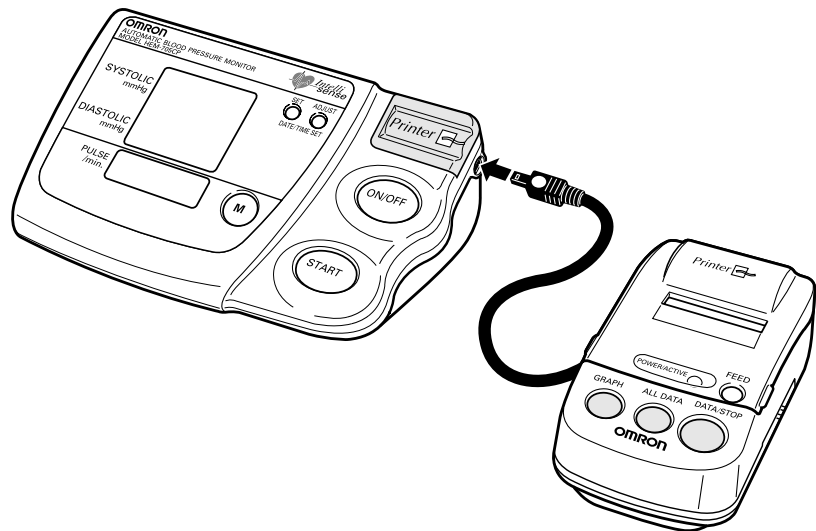

# HOW TO LOAD PRINTER PAPER

1. Open printer cover in the direction indicated by the arrow symbol and remove paper roll from the main unit.

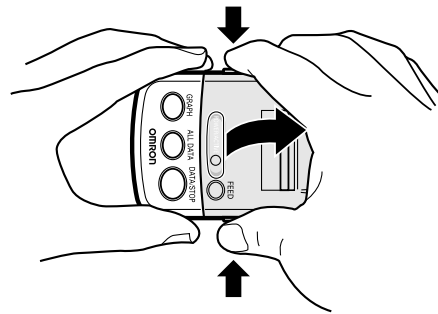

2. Peel of the glued edge of the printing paper included with the unit, and cut the first 4 inches with a pair of scissors.

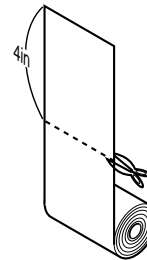

3. Press the PAPER FEED button while inserting the edge of the printing paper into the paper feeding slot. When the edge of the paper protrudes sufficiently, release the PAPER FEED button.

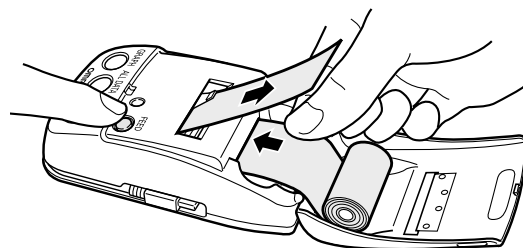

4. Close the plastic printer cover. Make certain that the paper sticks out from the top when the cover is replaced.

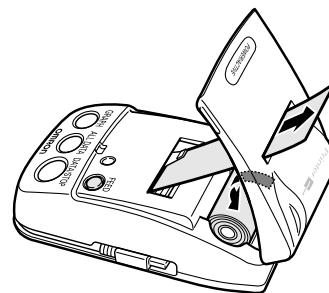

5. Thermal sensitive paper is supplied with the unit. Use only thermal paper of similar size (width approx. 38mm) and roll diameter (not to exceed approx. 26mm). These rolls of paper (model number 90TRP) can be ordered from OMRON HEALTHCARE, INC., 300 Lakeview Parkway, Vernon Hills, IL 60061 (1-800-634-4350).

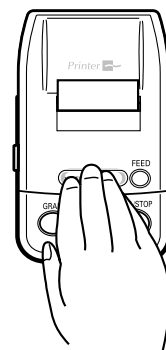

# HOW TO USE THE OPTIONAL AC ADAPTER

To avoid potential damage to the monitor, use only the exclusive AC adapter (Model HEM-ADPT1).

To connect the AC adapter

1. Insert the AC adapter plug into the AC Adapter jack on the back of the main unit.
2. Plug in the AC adapter into a 120V AC outlet (50 - 60 cycles).

To remove the AC adapter

To remove the AC adapter, disconnect the adapter plug from the AC outlet first and then disconnect the cord from the monitor's jack.

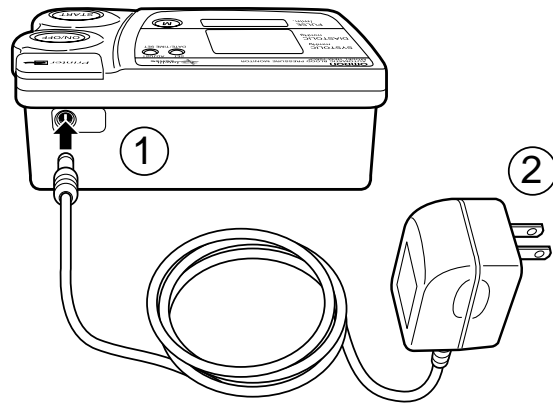

**NOTE:** The monitor is designed not to draw power from the batteries when the AC adapter is in use.

# HOW TO APPLY THE ARM CUFF

1. If the cuff is assembled correctly, the hook material will be on the outside of the cuff loop and the metal D-ring will not touch your skin.
2. If the cuff is not assembled, pass the end of the cuff furthest from the tubing through the metal D-ring to form a loop. The smooth cloth should be on the inside of the cuff loop.
3. Sit in a chair with your feet flat on the floor and place your arm on a table so that the cuff is at the same level as your heart.
4. Put your arm through the cuff loop. The bottom of the cuff should be approximately 1/2" above the elbow. The Green Marker on the cuff should lie over the brachial artery on the inside of the arm. Tube should run down center of arm approximately even with middle finger.

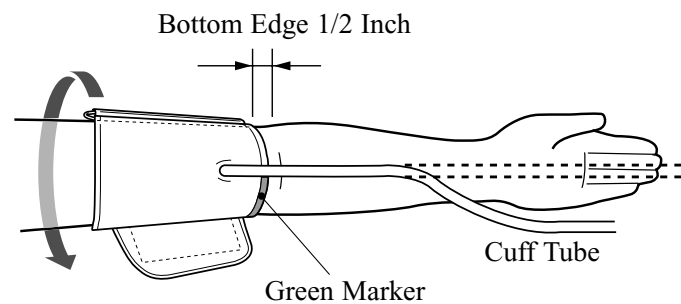
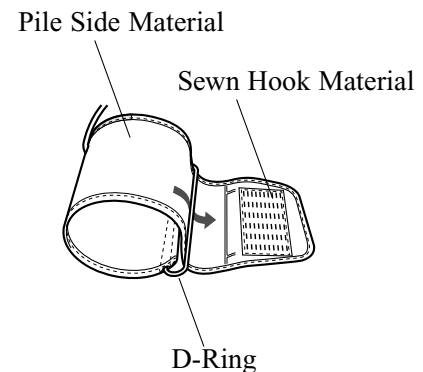
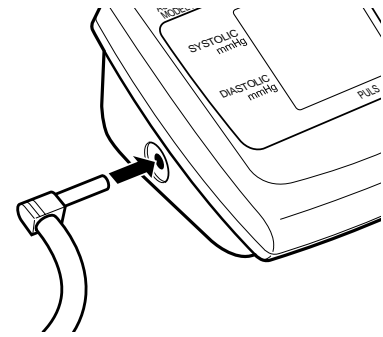

# HOW TO APPLY THE ARM CUFF

5. Pull the cuff so that the top and bottom edges are tightened evenly around your arm.

6. When the cuff is positioned correctly, press the sewn hook material **FIRMLY** against the pile side of the cuff.

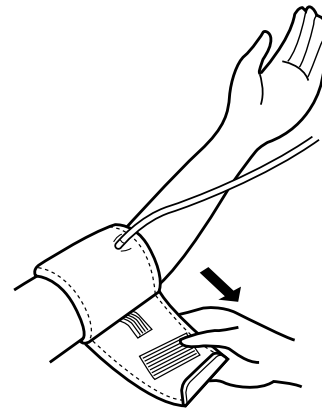

7. Make certain the cuff fits snugly around your arm. The cuff should make good contact with your skin.

**You should be able to fit your index finger between the cuff and your arm easily, so you can pull the cuff off and on.**

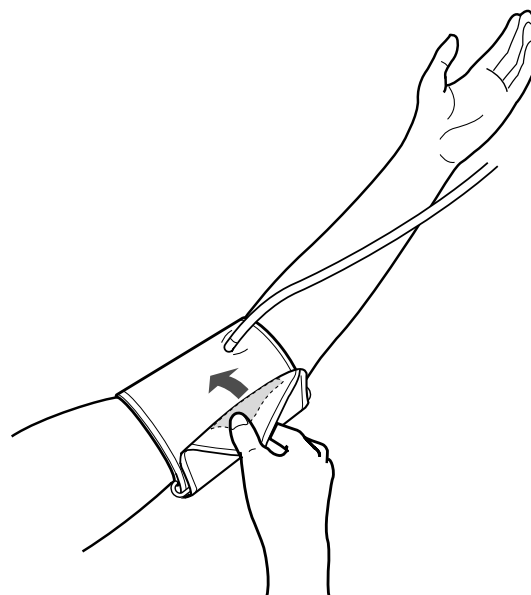

8. Relax your arm and turn your palm upward.

9. Be sure there are no kinks in the air tubing.

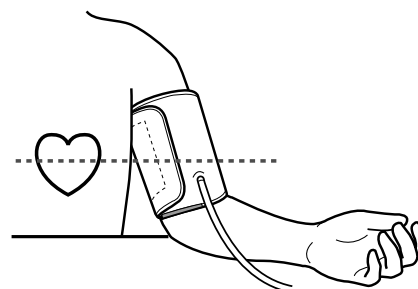

# HOW TO TAKE A READING

## 1. Press the ON/OFF button.

- All display symbols appear for approximately one second.
- When the monitor becomes ready to measure, the Heart Symbol appears on the display.

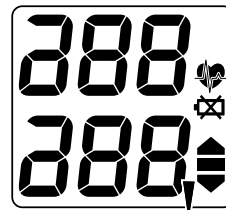

## 2. Press the START button and remain still.

As the cuff begins to inflate, the monitor automatically determines your ideal inflation level. Because this monitor detects the pulse even during inflation, do not move your arm and remain still until the entire measurement completes.

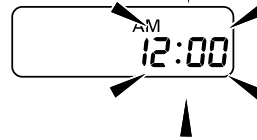

## 3. Inflation stops automatically and measurement is started.

As the cuff slowly deflates, decreasing numbers appear on the display and the Heart Symbol (♥) flashes at every heartbeat. In rare circumstances, a higher inflation may be necessary. In those cases, the monitor reinflates the cuff up to 30 mmHg higher than initial inflation and restarts the measurement.

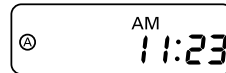
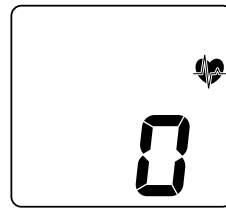

## 4. When the measurement is complete, the arm cuff completely deflates and your blood pressure and pulse rate are displayed.

NOTE: The monitor automatically stores blood pressure and pulse rate into the memory.

## 5. Press the ON/OFF button to turn the monitor off.

NOTE: If you forget to turn the monitor off, it will automatically shut itself off after five minutes.

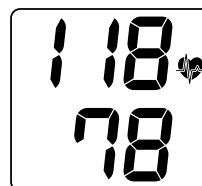
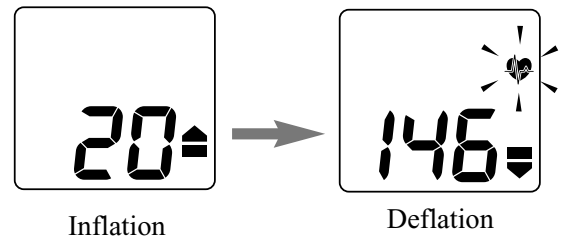

# HOW TO TAKE A READING

## Instructions for special conditions:

- If your systolic pressure is known to be more than 220 mmHg, push and hold the START button until the monitor inflates 30 to 40 mmHg higher than your suspected systolic pressure.

**NOTE: Do not apply more pressure than necessary.**

**The monitor will not inflate above 300 mmHg.**

- If you want to stop the measurement, push the ON/OFF button. The monitor will stop inflating and start deflating rapidly, then the monitor will turn off.

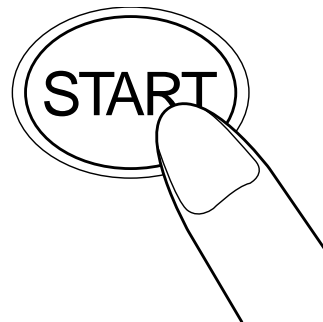

Continue to press button



# HOW TO USE THE MEMORY FUNCTION

This monitor has a memory capable of storing twenty-eight (28) sets of readings. Every time you complete the measurement, the monitor automatically stores blood pressure and pulse rate.

- Push the (M) button to recall stored readings while the Heart Symbol (♥) is displayed.
- When twenty-eight (28) sets of readings are stored in memory, the oldest set will be deleted to store a new set.

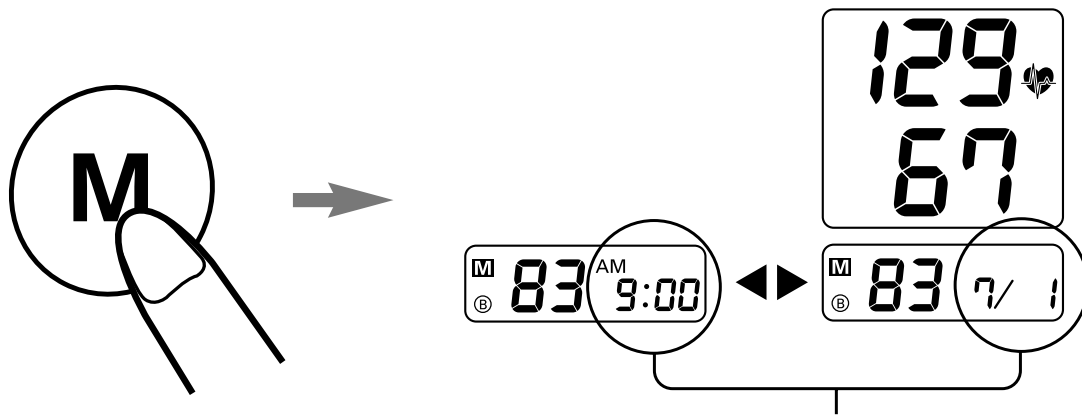

- Date and Time of stored readings will be alternately displayed.
- To delete stored readings, press the (M) button and the Start button simultaneously, then all the readings will be deleted.

NOTE: You can not delete the stored readings partially.

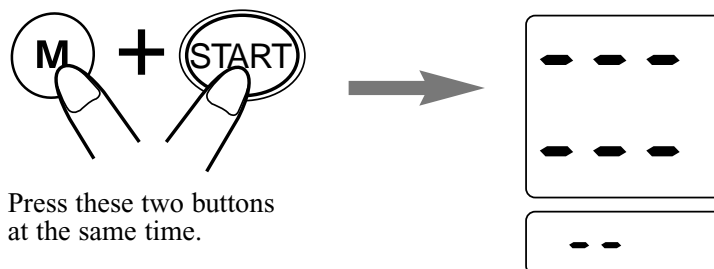

# HOW TO USE THE PRINTER-UNIT

The HEM-705CP has the ability to print all the readings stored in memory.

**NOTE:**

- Make sure printer-unit is connected to main unit (see How to Connect Printer-Unit)
- Do not use printer-unit without loading printer paper (see How to Load Printer Paper). Improper use will decrease operation life cycle of printer-unit.
- Main unit does NOT have to be ON to operate printer-unit.
- Printer-unit will automatically shut OFF when printing is completed.
- If you need to stop printing during printing process, press “DATA/STOP” button.

1. Press “DATA/STOP” to print measurement of most recent reading.

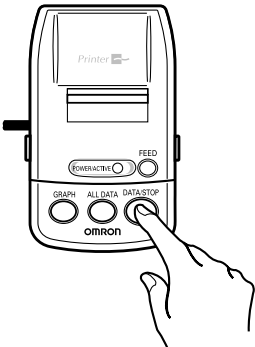

The numeric print-out will look like the following example:

Month/Date	7/9	6:36 AM	Time
Systolic Reading	SYS	117MMHG	
Diastolic Reading	DIA	67MMHG	
Pulse Reading	PULSE	77/MIN	

2. Press “ALL DATA” button to print a numerical list and average of all stored readings (stores a maximum of 28 readings).

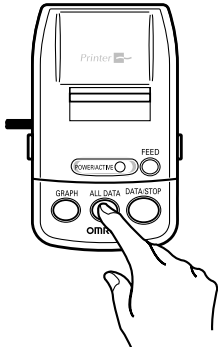

# HOW TO USE THE PRINTER-UNIT

The numerical print-out will list all stored readings (maximum of 28 readings) starting with the most recent reading to last stored reading:

	Systolic Reading Column	Diastolic Reading Column	Pulse Reading Column				
Month(s)	(3-6)	mmHg	/min				
Date	D. T.	SYS	DIA				
Time/Hour			PUL				
	20	15	113	75	67	Last reading stored	
	23	11	117	69	64		
	1	15	113	71	63	Most recent reading	
	3	14	110	67	66		
	5	7	112	66	64		
	15	7	110	61	64		
	20	12	106	66	65		
	3	12	110	65	64		
	10	12	108	61	67		
	12	14	111	56	62		
	14	7	107	64	64		
	21	15	111	64	64		
	22	12	121	62	66		
	4	6	112	64	63		
	*AV.		112	65	65		Average of all stored readings

- **Month(s)**

The month or months will be printed.

Example: If the blood pressure reading was stored between months March-June, then the printout will indicate “3-6”.

- **Date**

Only the day’s date (1-31) will be printed.

Example: If the blood pressure reading was stored on June 1st, then the printout will indicate 1 under the “D” column.

- **Time/Hour**

Only the hour (in military time) will be printed.

Example: if the blood pressure reading was stored at 3:00 PM, then the printout will indicate 15 under the “T” column.

**Note:** If Time and Date was not initially set up before taking blood pressure measurement (see How to Set Time and Date) on printer-unit, the numerical value will not appear on print-out for month, time/hour and date.)

# HOW TO USE THE PRINTER-UNIT

3. Press "GRAPH" button to print a graph of all stored readings (stores a maximum of 28 readings).

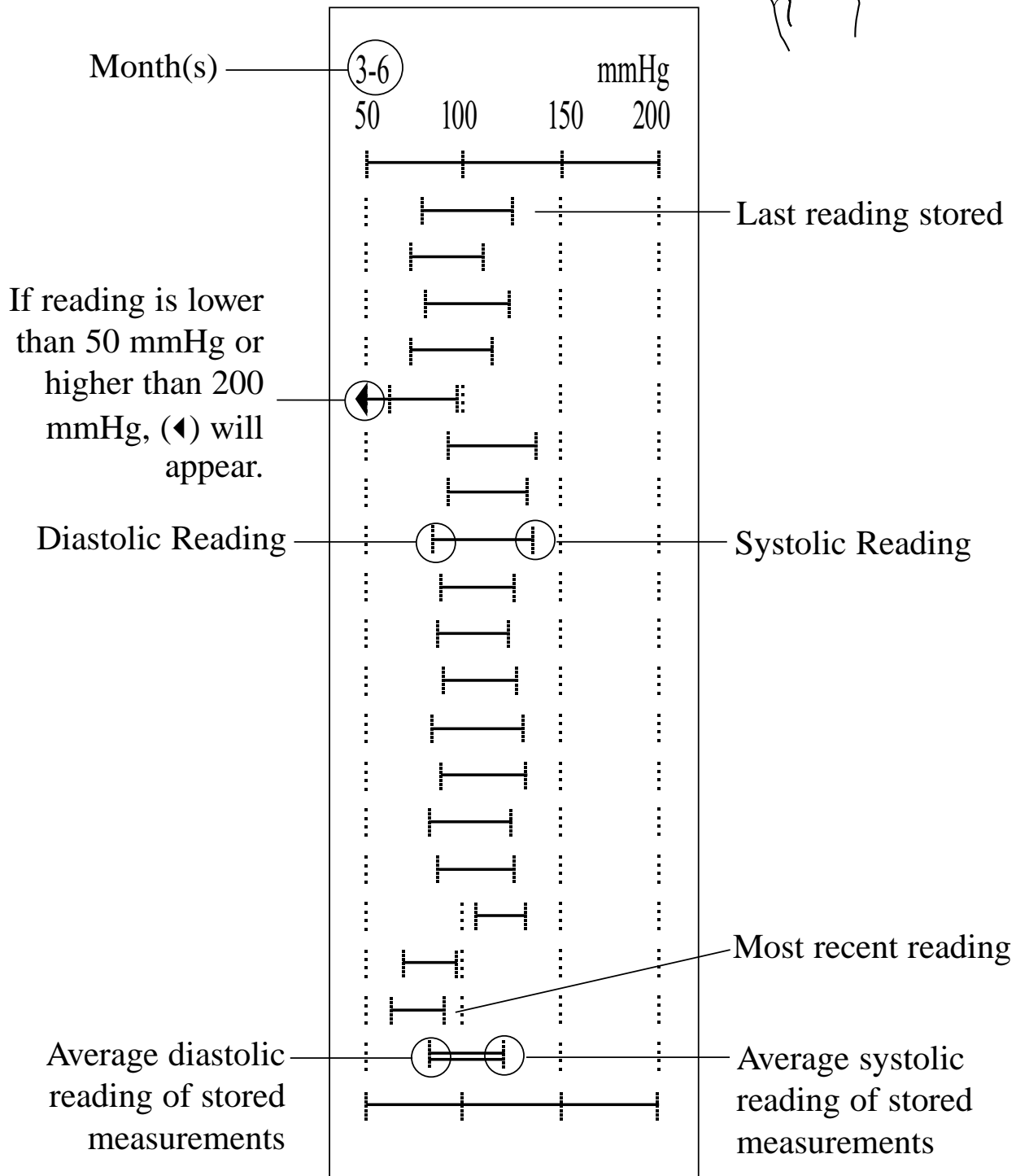
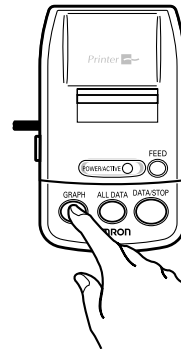

# TROUBLESHOOTING

## Main Unit:

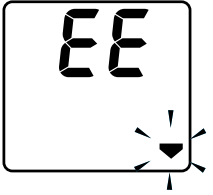
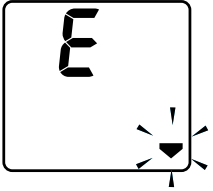
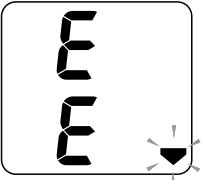
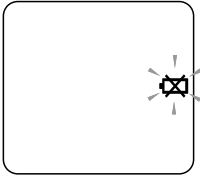
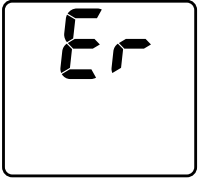
Error Indicator	Cause	Correction
	Cuff under-inflated.	Turn monitor off, wait 2-3 minutes and take another measurement. Repeat steps listed under "How to Take a Reading." If "EE" is displayed again, take another measurement by pressing and holding the START button as shown on instruction page 12 under "How to Take a Reading", instructions for special conditions.
	Movement during measurement.	Your cuff maybe wrapped too tightly around your arm.
	Cuff over-inflated (more than 300 mmHg).	Turn the monitor off, carefully read and repeat steps listed under "How to Take a Reading."
	Battery voltage is excessively low.	Replace all four "AA" batteries with new batteries.
	Problem caused by abnormal memory function.	Refer to warranty page for sending unit in for repair service.

If you continue to have difficulty obtaining a reading, call **OMRON HEALTHCARE CUSTOMER SERVICE TOLL FREE 1-800-634-4350**. Please tell the representative you have an OMRON Model HEM-705CP.

# TROUBLESHOOTING

## Printer Unit:

Error Indicator	Cause	Correction
Nothing is printed	Printer cable plug is not connected properly or damaged	Connect correctly reference p.10 Contact Omron Customer Service
	Batteries are worn	Replace with new batteries
	No readings stored	Take measurement then print
	Printer paper is not installed correctly	Install correctly
Power/Operation light is blinking, stopped printing	Batteries are worn	Replace with new batteries
No printer paper comes out	No printer paper installed	Take paper jammed from the printer and install again
	Printer paper jammed	
	Ran out of printer paper	Purchase new printer paper

If you continue to have difficulty obtaining a reading, call  
**OMRON HEALTHCARE CUSTOMER SERVICE TOLL FREE 1-800-634-4350.**  
 Please tell the representative you have an OMRON Model HEM-705CP.

# CAUTION

## CAUTION:

Changes or modifications not expressly approved by Omron Healthcare, Inc. could void the user's warranty.

### NOTE:

#### POTENTIAL FOR RADIO/TELEVISION INTERFERENCE (for U.S.A. only)

This product has been tested and found to comply with the limits for a Class B digital device, pursuant to part 15 of the FCC rules. These limits are designed to provide reasonable protection against harmful interference in a residential installation. The product generates, uses, and can radiate radio frequency energy and, if not installed and used in accordance with the instructions, may cause harmful interference to radio communications. However, there is no guarantee that interference will not occur in a particular installation. If the product does cause harmful interference to radio or television reception, which can be determined by turning the product on and off, the user is encouraged to try to correct the interference by one or more of the following measures:

- Reorient or relocate the receiving antenna.
- Increase the separation between the product and receiver.
- Connect the product into an outlet on a circuit different from that to which the receiver is connected.
- Consult the dealer or an experienced radio/TV technician for help.

#### POTENTIAL FOR RADIO/TELEVISION INTERFERENCE (for Canada only)

This digital apparatus does not exceed the Class B limits for radio noise emissions from digital apparatus as set out in the interference-causing equipment standard entitled "Digital Apparatus", ICES-003 of the Canadian Department of Communications.

Cet appareil numérique respecte les limites de bruits radioélectriques applicables aux appareils numériques de Classe B prescrites dans la norme sur le matériel brouilleur: "Appareils Numériques", ICES-003 édictée par le ministre des communications.

# CARE AND MAINTENANCE

To protect your monitor from damage, please **AVOID** the following:

- Subjecting your monitor and cuff to extreme temperatures, humidity, moisture, and direct sunlight.
- Folding the cuff and tubing tightly.
- Inflating the monitor over 280 mmHg.
- Disassembling the monitor.
- Subjecting the monitor to strong shocks (for example, dropping the monitor on the floor.)
- Do not clean the monitor with volatile liquids.  
**THE MONITOR SHOULD BE CLEANED WITH A SOFT, DRY CLOTH.**
- Do not clean cuff.



# WARRANTY

Your HEM-705CP IntelliSense™ Automatic Blood Pressure Monitor is warranted to be free from manufacturing defects for a period of five years under normal use. The five year warranty excludes the monitor cuff. **The cuff is warranted for a one year period.** This warranty extends only to the original retail purchaser.

Should repair be needed within the warranty period, ship the unit prepaid with the proof of purchase date and \$5.00 for return shipping and insurance to:

Omron Healthcare, Inc.  
Attn: Repair Department  
300 Lakeview Parkway  
Vernon Hills, IL 60061

Be sure to include the model number and your phone number on any correspondence.

We will either repair or replace (at our option) free of charge any parts necessary to correct defects in the materials or workmanship.

The above warranty is complete and exclusive. The warrantor expressly disclaims liability for incidental, special, or consequential damages of any nature. (Some states do not allow the exclusion or limitation of incidental or consequential damages, so the above warranty may not apply to you.)

Any implied warranties arising by the operation of law shall be limited in duration to the term of this warranty. (Some states do not allow limitations on how long an implied warranty lasts, so the above limitation may not apply to you.)

This warranty gives you specific legal rights, and you may have other rights which vary from state to state. As a condition to operation of your warranty, the enclosed registration card must be completed and sent to us within 10 days from the date of purchase.

## **FOR CUSTOMER SERVICE CONTACT:**

By phone toll free  
By using the feedback form at

1-800-634-4350  
[www.omronhealthcare.com](http://www.omronhealthcare.com)

# SPECIFICATIONS

## MAIN UNIT:

Model:	<b>HEM-705CP</b>
Display:	LCD Digital Display
Measurement Range:	Pressure: 0 to 299 mmHg Pulse: 40 to 180/minute
Accuracy/Calibration:	Pressure: $\pm 4$ mmHg Pulse: $\pm 5\%$ of reading
Inflation:	Automatic by electric pump
Deflation:	Active electronic control valve
Rapid Pressure Release:	Active electronic control valve
Pressure Detection:	Capacitive pressure sensor
Measurement Method:	Oscillometric method
Pulse Wave Detection:	Capacitive pressure sensor
Power Source:	4 "AA" batteries or AC adapter
Battery Life:	Approximately 300 uses
Operating Temperatures/Humidity:	50°F to 104°F (10°C to 40°C) 30 to 85% RH maximum
Storage Temperatures/Humidity:	-4°F to 140°F (-20°C to 60°C) 10 to 95% RH maximum
Main Unit Weight:	Approximately 13.4 oz (380 g) not including batteries
Main Unit Dimensions:	Approximately 4 ½" (l) x 7" (w) x 2 ½" (h) (115 mm x 177 mm x 71 mm)
Cuff Dimensions:	Approximately 5 1/2" x 19" (140 mm x 480 mm)
Cuff Circumference:	Fits arm circumference 9" to 13"
Accessories:	Arm cuff, printer-unit, paper rolls (2), instruction manual

# SPECIFICATIONS

## PRINTER UNIT:

Power Source:	4 “AA” batteries
Battery Life:	Approximately 300 uses (current data)
Paper Usage:	Approximately 200 uses for 1 roll (current data)
(Printer) Weight:	Approximately 6 oz. (170 g) (not including batteries)
(Printer) Dimensions:	Approximately 4 $\frac{4}{5}$ " (l) x 2 $\frac{4}{5}$ " (w) x 2" (h) (123 mm x 72 mm x 50 mm)

**NOTE:** These specifications are subject to change without notice.

\*Optional accessories: large cuff (fits arms 13" to 17" in circumference) and small cuff (fits arms 7" to 9" in circumference) are sold separately.

For Customer Service  
Call Toll Free  
**1-800-634-4350**

Manufactured by OMRON

Distributed by:  
**OMRON HEALTHCARE, INC.**  
300 Lakeview Parkway  
Vernon Hills, Illinois 60061  
[www.omronhealthcare.com](http://www.omronhealthcare.com)

Copyright © 2001 OMRON HEALTHCARE, INC.

705CPINST Rev A