

CBPM24

Ambulatory blood pressure monitor
with central blood pressure measurement

User Manual

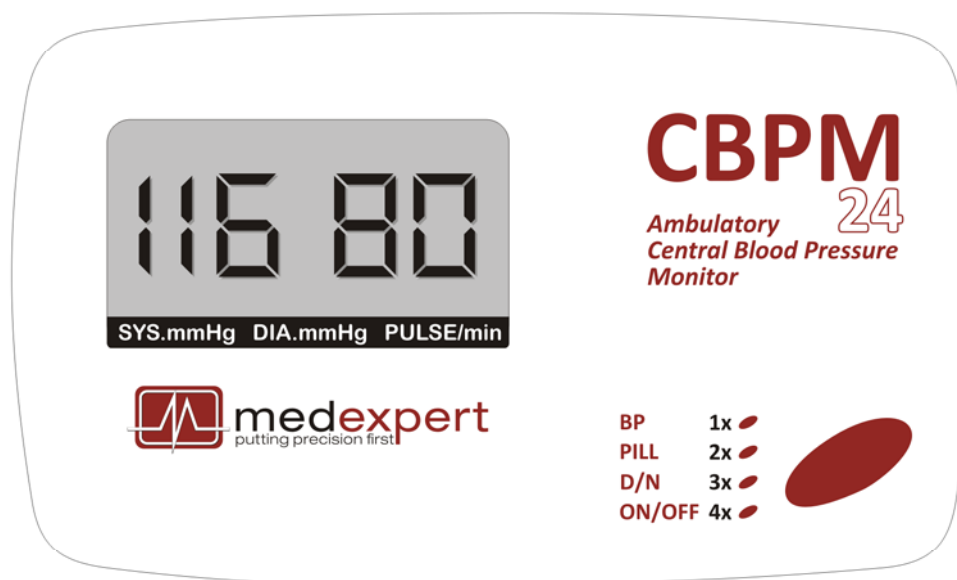

With wireless IrDA communication

Table of Contents

1. Introduction	4
1.1. Contents of the manual	5
1.2. Supplementary Information and Helpful Hints	5
1.3. Warranty	6
1.4. General Information	6
2. The Medexpert CBPM24 device	8
2.1. Explanation of symbols	8
2.2. Accessories	10
2.3. Installing the Device	11
2.4. Operations Instructions	12
2.4.1. Functions of the button on the device	12
2.4.1.1. One short push of the button	12
2.4.1.2. Two short pushes on the button	13
2.4.1.3. Three short pushes on the button	14
2.4.1.4. Four short pushes on the button	14
2.4.2. Data transmission	14
2.4.3. Error codes for users	15
2.4.4. Sound signals	16
2.4.5. Using the device for ambulatory blood pressure monitoring	16
3. Specifications	17

1. Introduction

Thank you for choosing Medexpert CBPM24. The Medexpert CBPM24, ambulatory blood pressure monitor is a professional device, for clinical and ambulatory requirements, validated according to the British Hypertension Society and the Association for the Advancement of Medical Instrumentation standards. The device uses oscillometric method for blood pressure determination. It can also be used for conventional home measurements, executed by the patients, offering a high level measuring quality and additional features.

Medexpert CBPM24 device is controlled by the Medexpert TensioWin™ software. The measurement schedule and the blood pressure readings are loaded via infrared communication from and to the physician's PC, respectively.

Automatic measurements can be set for up to 48 hours, with frequencies ranging from 10 to 90 minutes. Separate measurement frequencies can be set for the “active” daytime, “passive” night-time, and for a third “special” period.

Four different types of blood pressure measuring plans with different measuring frequencies can be programmed even by pressing the button of the device without using a computer. This measuring plan covers a 24-hour period from the time of programming.

The measured data, namely the systolic and diastolic BP value, the pulse rate, the date and time of the measurement will be stored in the EEPROM of the device.

Apart from the programmed measurements, the patient may start a manual measurement (e.g.: he shows symptoms or feels sick). This can be done by a simple push button operation. All manually initiated measurements are stored and displayed on the software report.

The Medexpert CBPM24 can be used without the software program, for conventional, manually started BP home monitoring. The high accuracy of the measurements and the storage of the measured data offer greater flexibility. The storage capacity of the device is 1000 measurements.

Copyright © 2011 Medexpert Ltd., Budapest, Hungary. All rights reserved. Under the copyright laws, this manual cannot be reproduced in any form without prior written permission of Medexpert Ltd.

Every effort has been made to ensure that the information in this manual is accurate. Succeeding models and manuals are subject to change without notice.

Medexpert is not responsible for printing or clerical errors.

This Manual is produced on the assumption that the operator is an experienced user of the Windows 2000 / XP / Vista operating Systems.

If the operator is not familiar with Windows operations, please refer to the On-line Help of Windows or the Windows User Manual.

Medexpert CBPM24 is an unregistered trademark of Medexpert Ltd.

Other company and product names mentioned herein may be trademarks of their respective companies.

1.1. Contents of the manual

This manual helps you in setting up and starting to use the Medexpert CBPM24 device.



Attention! Before first use, please read and understand this document carefully.

1.2. Supplementary Information and Helpful Hints

- This device does not produce electromagnetic disturbances during its operation and its immunity to the environmental disturbances is also good. The download of the measured data to the physician's PC is done by infrared communication. The electromagnetic compatibility between the device and the PC is guaranteed. EMC classification: A.
- Regular service is recommended by an approved agent at least every two years to maintain optimum performance and accuracy.
- The cleaning of the cuff is by wiping over with a damp cloth only.
- The handling, storage, wrapping, substance-conservation and transportation of the producer's devices are defined in accordance with the general Quality Control Requirements.
- The device meets the following requirements:

EN 60601-1:1995 +A1:1993+A2:1995+A13:1996
EN 60601-1-2:2001
EN 1060-1:1995 +A1:2002
EN 1060-3:1997
MSZ EN 1060-4:2005
EN ISO 14971:2000
93/42/EEC :1993

ESH International Protocol 2002

1.3. Warranty

Medexpert Ltd undertakes 2 years of warranty for the device (12 months for the accessories). The repairs are done by Medexpert Ltd at the place below.

Head office and service:

Medexpert Ltd.

Törökkő u. 5-7.

Budapest H-1037

Hungary

Phone: +36-1 250 4490

Fax: +36 1 433 3795

Web: www.medexpert.hu











E-mail: arterialcare@medexpert.hu

1.4. General Information, warnings and precautions

We strongly suggest that you carefully study the Operating Instructions of this multipurpose blood pressure monitoring device and that you note the listed precautions.

For optimum performance it is recommended to use Nickel-Metal Hybrid (Ni-MH) rechargeable batteries, or Nickel Cadmium (NiCd) rechargeable batteries, with 1500 mAh capacity, size AA.

The Medexpert CBPM24 can also be used with 1.5 V long life batteries, size AA.

Attention!	
	Attention! If the device is not used for a longer period, remove the batteries from the battery compartment. Furthermore, please, keep the device out of reach of children if it is out of use.
	Pay special attention when applying the ambulatory BPM device to patients with serious mobility or other impairments, also unconscious or otherwise incapable patients and patients with coagulation disturbances. For children it is also recommended to apply the unit with special care. Children should not use the device on their own!
	Do not remove the outer cover of the device. The Medexpert CBPM24 24-hour BPM device is sophisticated, multipurpose, software controlled measuring apparatus. In case of any problem, turn to a qualified service.
	Only use with cuffs supplied by Medexpert Ltd. Use of cuffs supplied by a third party can lead to erroneous measurement results.
	Confirm blood pressure measurement with auscultation when erroneous results are suspected.
	Do not use a microwave device (e.g. mobile phone) near the unit during measurement.
	Do not use the device when it is exposed to mechanical vibration (e.g. in vehicles).
	Prevent the device to be exposed to direct sunlight, to get in contact with liquid or from excessive mechanical impact.
	Do not disassemble the device.
Patient safety	
	The device has an integrated safety mechanism, which prevents the cuff pressure to exceed 300 mmHg. If however the inflation continues above this value or the pressurization lasts too long, unplug the pneumatic connector of the cuff from the device and remove the cuff from the subject.
	Do not use the device on an arm, which is being injected with intravenous injection.

	Do not use on neonates.
---	-------------------------

2. The Medexpert CBPM24 device

2.1. Explanation of symbols

- 1 Name of the device
- 2 Function button (Offering five menu options, see section 2.4.1.)
- 3 Command symbols (see section 2.4.1.)
- 4 LCD display
- 5 Air connector

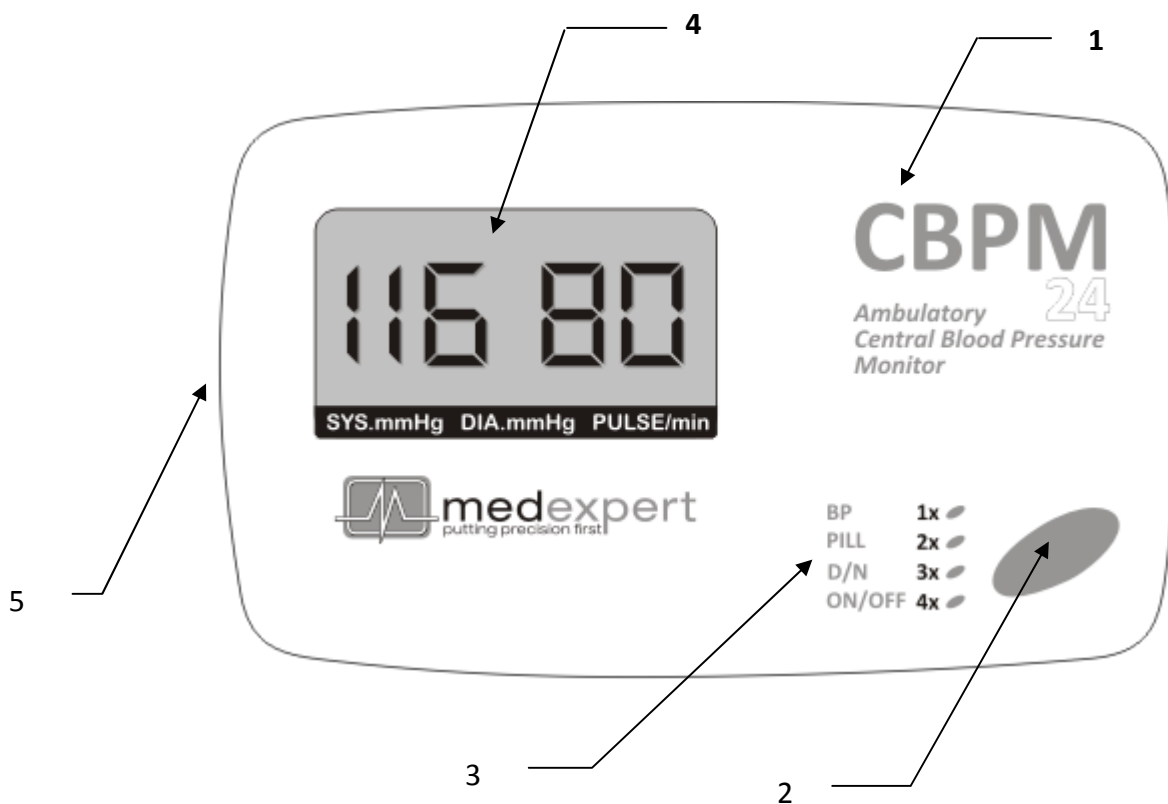
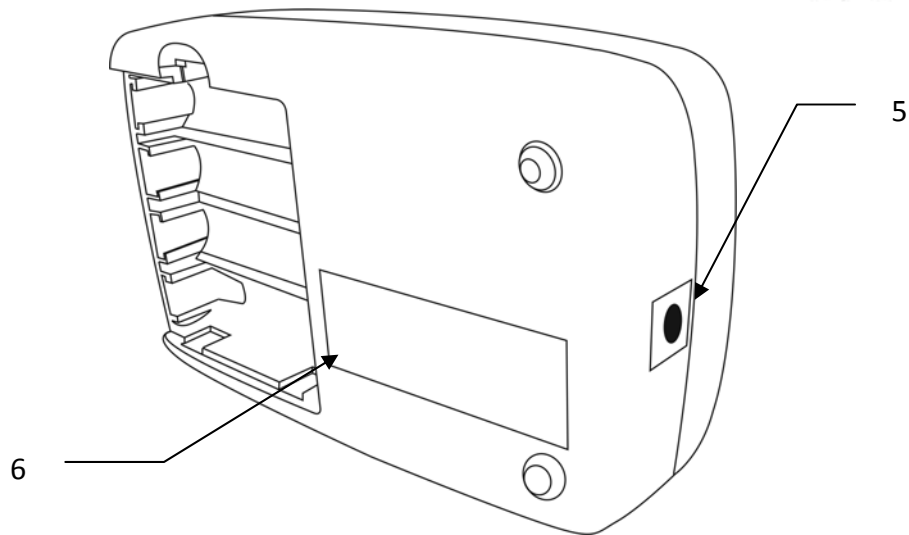

Figure 1.



The symbols on the bottom of the device are shown in Figure 2.

- 6 The manufacturer's label
- 7 The name of the apparatus
- 8 The type number of the apparatus
- 9 MDD certification of device (II a)
- 10 The nominal voltage range applicable with batteries
- 11 The classification of the protection against electric shock
Classification: patient's side: CF
- 12 Calling the attention to read thoroughly the present User's Manual
- 13 Certification mark guaranteeing that the apparatus complies with the prescriptions and requirements of the European Union.
- 14 Serial number
- 15 Operating ambient temperature range
- 16 Year of manufacturing

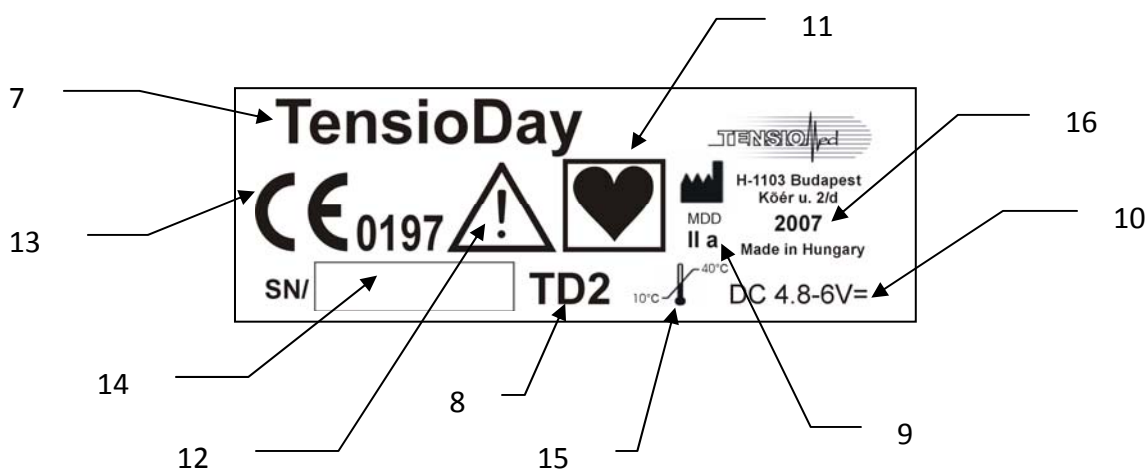

Figure 2.

- 17 Infrared communication window

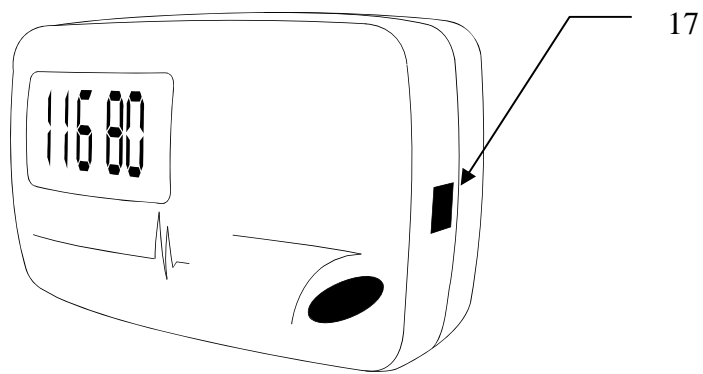

Figure 3.

2.2. Accessories

Medexpert CBPM24 ambulatory blood pressure monitoring device (Figure 1), is supplied with the following accessories:

- pouch for the device with belt
- four, AA size batteries
- 3 different cuffs
- Medexpert TensioWin™ software on CD
- User manual
- IrDA adapter

For the 3 different size cuffs the dimensions are:

	Bladder Dimensions	Sleeve Dimensions	Arm Circumference
Cuff 01	34 × 8 cm	62 × 9 cm	34 - 43 cm
Cuff 02	26 × 8 cm	52 × 9 cm	26 - 32 cm
Cuff 03	18 × 6 cm	38 × 7 cm	18 - 22 cm

Note: Correct cuff dimensions are important to achieve optimal performance and accuracy.

2.3. Installing the Device

Medexpert CBPM24 is a battery operated device.

- Insert 4 durable alkaline AA batteries into the Device with taking care of the right polarity (see Figure 4)
- Or insert 4 AA sized rechargeable Ni-MH or NiCd batteries as per the above instruction. (Please note that new batteries must be pre-charged.)
 - For problem-free operation minimum 1,500 mAh chargeable Ni-MH or NiCd batteries are recommended.

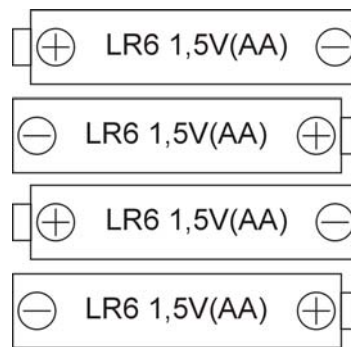

Figure 4.

The Ni-MH, NiCd batteries are rechargeable approximately one thousand times. If the capacity of the rechargeable batteries is low, it is shown on the LCD automatically. In this case please, change all the four batteries not only the ones you think are weak.

The clock circuits of the device are powered by a type Ni-Cd HA 35 storage battery and it is continuously charged by the AA batteries, therefore the clock time is held and resetting the time is unnecessary between battery changes.

If you do not intend to use the device for a long period of time, remove the batteries and store them in a cool and dry place. Do not apply heat to the batteries, or an internal short circuit may occur. Dispose of spent batteries immediately in an environmentally - safe way. The batteries and charging appliances have their own Instructions for use, we suggest you study them and follow manufacturers' guidelines.

In case you do not have a infrared communication adapter or a built-in infrared in your PC, connect the infrared communication adapter to your PC and do the setting. If you find it necessary, ask for the help of your system supervisor who is responsible for your computer. Allow the infrared communication in your PC. Then if the device is within 1 m from the infrared adapter, the computer will get into connection with the device via the software. To transmit data, it is necessary to use the Medexpert TensioWin™ program, of course.

2.4. Operation Instructions

To set up the 24-hour automatic BPM in operating mode first check power supply. The frequency of measurements will be downloaded from the physicians PC via infrared communication.

To operate the device, there is one single button. The measured data and information about the status of the device appear on the LC Display.

The patient, by the one single button can give four different commands to the device.

2.4.1. Functions of the button on the device

After switching on, the device first performs the controlling measurement as follows:

- The voltage control of the batteries. The measured value appears on the display. If the batteries are well charged, the measured potential will be between 5,4V - 4,4V. (The nominal potential is 4,8V)

If the voltage is under 4,4 V the batteries need replacing. The replace battery message will be displayed.

If long life batteries are used to power the device the measured nominal voltage will be 6V. The battery change symbol will be the same as above.

If the battery voltage is adequate, the device will be ready for measuring and the current computer time will be displayed. Medexpert CBPM24 is ready for operation:

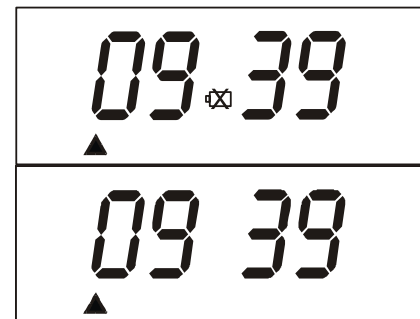

5.6V

2.4.1.1. One short push of the button starts a manual measurement.

During the ambulatory measuring mode, there might be a need for manual measurements, for example when the patient feels unwell. One short push of the button sets up the measurement. The exact time disappears on the display and then:

- the test figure of the display appears (see adjacent figure)
- the voltage of the batteries are checked (see adjacent figure)

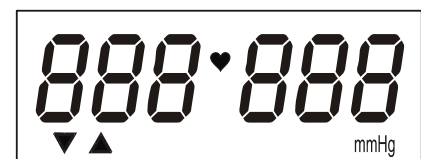

5.6

- calibration takes place, setting the zero pressure (see adjacent figure)

CAL 0

After that, the measurement starts by the inflation of the cuff, signaled on the display (see adjacent figure).

87

The device checks the placement of the cuff during inflating. If the cuff on the arm is too loose or not the proper size of cuff has been chosen (e.g. it is bigger), the following sign will be on the display accompanied by a beeping signal. Check the cuff and its tightness and repeat the blood pressure measurement.

CUFF

The deflation of the cuff is shown by the adjacent figure

69

After this process the device shows the systolic and diastolic BP values

128/96

Then the pulse rate is shown on the display, and the device stores all the measured data, including the date and exact time.

PUL 68

At any time during a reading the patient can terminate a reading by pressing once the single button. A termination symbol will appear on the display for 10 sec (see adjacent figure). Then the time will appear and the units ready for measurement, for manual and programmed mode.

OFF

2.4.1.2. Two short pushes on the button (Pill): allows the patient to keep his "electronic diary" concerning taking his (antihypertensive) medication.

Pill

After taking his medicine, two short pushes on the button stores the date and time in the memory. During a day, it is possible to store additional pill consumptions. By downloading all the data from the device to the physician's PC, he will be able to monitor the medication intake and therefore the compliance of the patient.

If the memory of the device is full, this will appear on the display.

FULL

2.4.1.3. Three short pushes on the button allows the patient to indicate the time of going to bed and waking up in the tabulated list of measurements. The device indicates the waking up by a triangle showing upwards and by a triangle showing downwards when the patient goes to bed.

2.4.1.4. By four short pushes on the button, the device can be switched off. You will see then “OFF” on the display. In this state the series written above cannot be applied and the measuring plan you set in the device will be interrupted. If you intend to use the device again, press the button again five times. Then “OFF” will disappear from the display, all functions of the device can be used again and the set measuring plan will be continued.

OFF

2.4.2. Data transmission

The device downloads all the stored data to the physician's PC via infrared communication. The information loaded consists of:

- the systolic and diastolic blood pressure values (in mmHg)
- the pulse rate per minute
- the distinction between programmed and manual measurements
- the date and time of the measurement
- the active or passive period
- the diary of medication intake.

If a infrared communication adapter is placed within the range of the device and it works - as its operation is permitted - the device and the PC will connect automatically. This sign will appear on the LCD display. The actual data transmission does not happen, yet this can be started by the Medexpert CBPM24 program.

IrDA

During the operation of the infrared communication between the device and the PC, when the actual data transmission is on, the following sign will appear on the LCD display.

CO PC

2.4.3. Error codes for users

The error codes, which appear on the LCD display, and their meanings are described below. Please, note that you should not make any conclusions if an error appears once because the movements of the patient can imitate several types of errors. If the device cannot measure the blood pressure (e.g. because of movement), the measurement will be interrupted. With the Medexpert TensioWin™ program - in case of a faulty measurement - it is possible to set the device to repeat it according to the measuring plan after 1 minute.

The meanings of the error codes shown by the device are as follows:

1	The device could not measure the patient's blood pressure within the measuring time
3	The measurement was interrupted due to the weakness of the battery
31	The cuff is not connected to the device
32	The cuff tube is broken or something got into the tube (e.g. water).
33	The cuff (or device) is leaking
34	The cuff is not on the patient's arm
35	The measurement was interrupted for some reason (e.g. because the patient pressed the button).
91-97	The BP measurement was not successful due to the failure of the device or the batteries are weak
100	The measured result cannot be considered as a real BP value or the patient has arrhythmia
101	The measuring circumstances e.g. the moving of the patient, disturbs the measurement
102	The device cannot sense the HR
110	The measured result cannot be considered as a real BP value because of some movement or arrhythmia
111	systole > max. inflation
115	The HR cannot be calculated or cannot be considered as a real HR value
116	Not enough evaluable results either from sys or from dia.

2.4.4. Sound signals

- If the device is working, beeping signals can be heard when pressing its button.

2.4.5. Using the device for ambulatory blood pressure monitoring

- place the cuff on the non-dominant arm
- place the cuff with the tube exiting the cuff upward in the region of the brachial artery. Make sure that the hosing allows for free ambulation
- to avoid skin irritation a thin shirt might be used below the cuff
- the tube of the cuff should be inserted into the black opening on the left side of the device. **Attention! Please, take care of the connection of the cuff because it should not be too loose, it should not leak. You can connect it properly if you insert the plug with a twisting motion until it stops**
- during measurements avoid excessive muscle movement, particularly in the arm, as this may lead to longer measurement or measurement error and it may decrease the accuracy of the measurement
- Ask the patient to keep a diary on his/her daily activities, symptoms, and the time of going to bed and waking up in the morning

3. Specifications

<i>Power Source:</i>
4 long life batteries, size AA
<i>The mode to prevent electric shock:</i>
The device is powered by inside, low voltage source
<i>The category to prevent electric shock:</i>
CF type patient - part
<i>Display:</i>
Liquid Crystal Display
<i>Data Storage:</i>
EEPROM, Flash memory
<i>Data Transmission:</i>
Infrared
<i>PC interface:</i>
IrDA communication adapter
<i>Computer requirements:</i>
Windows XP + service pack 3
<i>Operating environment:</i>
10 - 40 ° C
<i>Humidity:</i>
30 - 85 %
<i>Size:</i>
128x77, 5x45, 5 mm
<i>Weight:</i>
310g (including batteries)
<i>Blood Pressure measurement method:</i>
Oscillometric
<i>Data Storage:</i>
Max 1000 measurements
<i>Blood Pressure measurements range:</i>
30 - 280 mmHg
<i>Static accuracy:</i>
±3 mmHg, or ± 2 % of the measured value
<i>Measuring accuracy:</i>
Systolic: 94 out of 99 comparisons were within 5 mmHg (95%), in case of 33 out of 33 patients, 2 comparisons out of 3 were within 5 mmHg, 0 out of 33 patients, where none of the measurements out of 3 were within 5 mmHg
Diastolic: 93 out of 99 comparisons were within 5 mmHg (94%), in case of 32 out of 33 patients, 2 comparisons out of 3 were within 5 mmHg, 0 out of 33 patients, where none of the measurements out of 3 were within 5 mmHg
Average difference from the auscultatic (Korotkov) measurements: (systolic / diastolic): 0.5/-0.4 mmHg
The range of the difference (systolic/diastolic): 2.8/2.8 mmHg
<i>Pressure sensor:</i>
Piezo-resistive
<i>Inflation:</i>
Automatically controlled pump
<i>Safety:</i>
Maximum inflation 280 mmHg
<i>Deflation:</i>
Automatic
<i>Working mode of the device:</i>
Continuous



CBPM24