

AND

Digital Blood Pressure Monitor

Model UA-854

Instruction Manual
Original

ENGLISH

Manuel d'instructions
Traduction

FRANÇAIS

Manual de Instrucciones
Traducción

ESPAÑOL

Manuale di Istruzioni
Traduzione

ITALIANO

Bedienungsanleitung
Übersetzung

DEUTSCH

使用手冊
翻譯

中文

Contents

Dear Customers	1
Preliminary Remarks.....	1
Precautions	2
Identification.....	3
Symbols	4
Operation Mode	5
Using The Monitor.....	6
Installing / Changing The Batteries.....	6
Connecting The Air Hose.....	6
Connecting The AC Adapter	6
Adjusting The Built-in Clock.....	7
Setting Three Reminders	7
Alarm ON/OFF Mark On The Display.....	8
Selecting The Correct Cuff Size.....	8
Applying The Arm Cuff.....	8
How To Take Proper Measurements.....	9
Measurement.....	9
After Measurement	9
Measurements.....	10
Normal Measurement	10
Measurement With The Desired Systolic Pressure.....	11
Notes For Proper Measurement.....	11
Recalling Memory Data.....	12
Recalling Memory Data	13
Clearing The Memory Data	13
What Is An Irregular Heartbeat	14
Pressure Bar Indicator	14
WHO Classification Indicator	14
About Blood Pressure	15
What Is Blood Pressure?.....	15
What Is Hypertension And How Is It Controlled?.....	15
Why Measure Blood Pressure At Home?.....	15
WHO Blood Pressure Classification.....	15
Blood Pressure Variations	15
Troubleshooting.....	16
Maintenance.....	17
Technical Data	17

Dear Customers

Congratulations on purchasing a state-of-the-art A&D blood pressure monitor, one of the most advanced monitors available today. Designed for ease of use and accuracy, this device will facilitate your daily blood pressure regimen.

We recommend that you read through this manual carefully before using the device for the first time.

Preliminary Remarks

- This device conforms to the European Directive 93/42 EEC for Medical Products. This is made evident by the **CE**₀₁₂₃ mark of conformity. (0123: The reference number to the involved notified body)
- The device is designed for use on adults only, not newborns or infants.
- Environment for use: The device is for use in the home healthcare environment.
- This device is designed to measure blood pressure and pulse rate of people for diagnosis.

Precautions

- ❑ Precision components are used in the construction of this device. Extremes in temperature, humidity, direct sunlight, shock or dust should be avoided.
- ❑ Clean the device and cuff with a dry, soft cloth or a cloth dampened with water and a neutral detergent. Never use alcohol, benzene, thinner or other harsh chemicals to clean the device or cuff.
- ❑ Avoid tightly folding the cuff or storing the hose tightly twisted for long periods, as such treatment may shorten the life of the components.
- ❑ The device and cuff are not water resistant. Prevent rain, sweat and water from soiling the device and cuff.
- ❑ Measurements may be distorted if the device is used close to televisions, microwave ovens, cellular telephones, X-ray or other devices with strong electrical fields.
- ❑ Used equipment, parts and batteries are not treated as ordinary household waste, and must be disposed of according to the applicable local regulations.
- ❑ When the AC adapter is used, make sure that the AC adapter can be readily removed from the electrical outlet when necessary.
- ❑ When reusing the device, confirm that the device is clean.
- ❑ Do not modify the device. It may cause accidents or damage to the device.
- ❑ To measure blood pressure, the arm must be squeezed by the cuff hard enough to temporarily stop blood flow through the artery. This may cause pain, numbness or a temporary red mark to the arm. This condition will appear especially when measurement is repeated successively. Any pain, numbness, or red marks will disappear with time.

Contraindications

The following are precautions for proper use of the device.

- ❑ Do not apply the cuff to an arm with another medical electrical equipment attached. The equipment may not function properly.
- ❑ People who have a severe circulatory deficit in the arm must consult a doctor before using the device, to avoid medical problems.
- ❑ Do not self-diagnose the measurement results and start treatment by yourself. Always consult your doctor for evaluation of the results and treatment.
- ❑ Do not apply the cuff on an arm with an unhealed wound.
- ❑ Do not apply the cuff on an arm receiving an intravenous drip or blood transfusion. It may cause injury or accidents.
- ❑ Do not use the device where flammable gases such as anesthetic gases are present. It may cause an explosion.
- ❑ Do not use the device in highly concentrated oxygen environments, such as a high-pressure oxygen chamber or an oxygen tent. It may cause a fire or explosion.



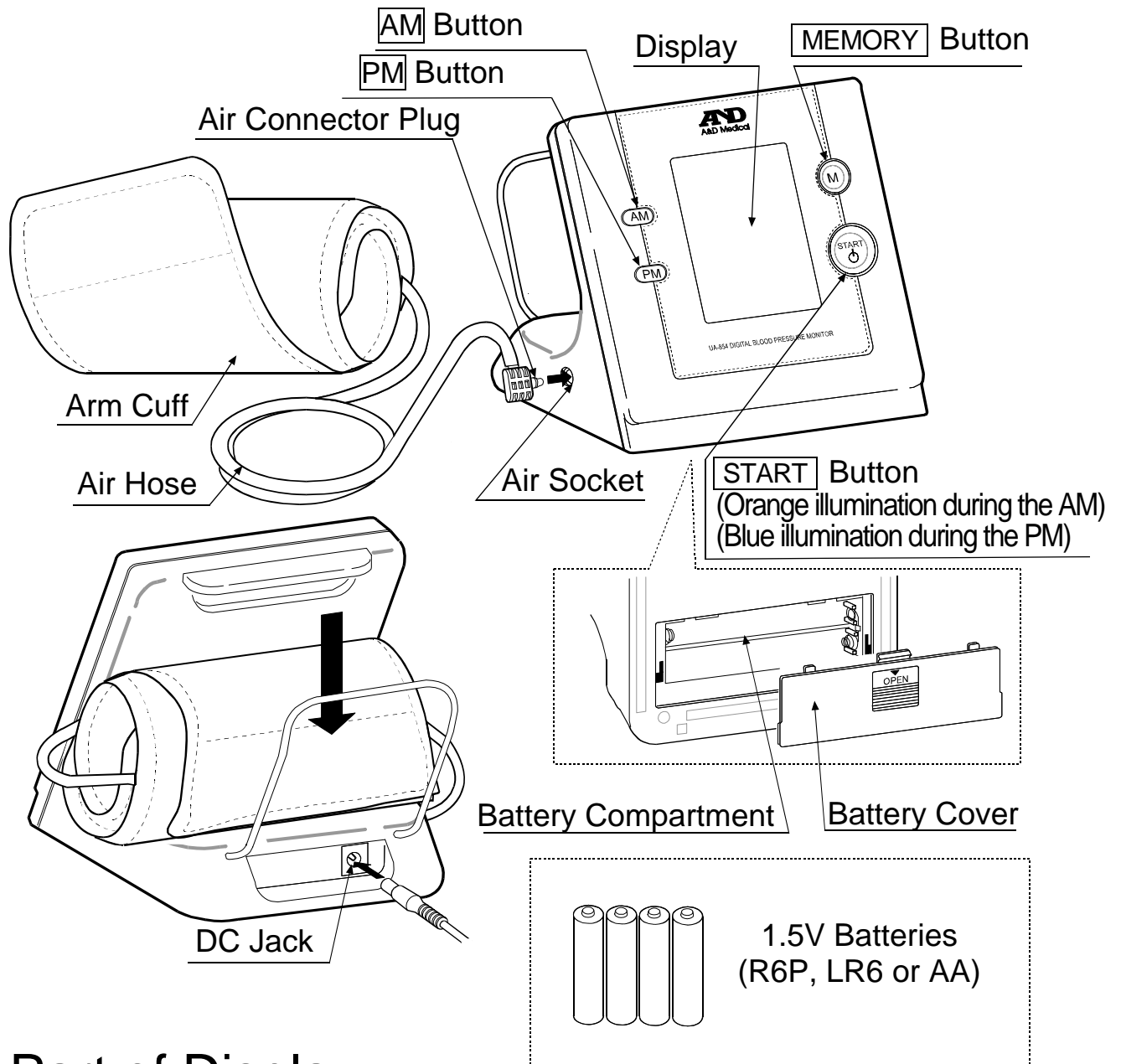



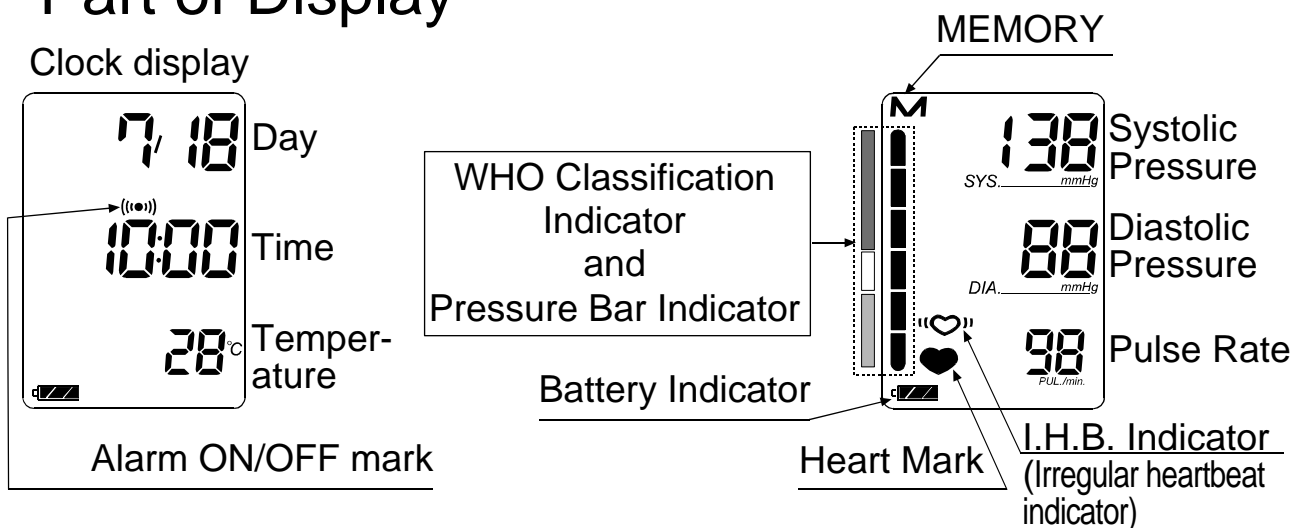



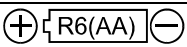



Identification



Part of Display



Symbols

Symbols	Function / Meaning	Recommended Action
	Standby and Turn the device on.	_____
	Battery installation guide	_____
	Direct current	_____
SN	Serial number	_____
2007 	Date of manufacture	_____
	Type BF: Device, cuff and tubing are designed to provide special protection against electrical shocks.	_____
	The indicator that appears while measurement is in progress. It blinks when the pulse is detected.	Measurement is in progress. Remain as still as possible.
	Irregular Heartbeat indicator. (I.H.B.) The indicator that appears when an irregular heartbeat or any excessive body movement is detected during the measurement.	_____
M	Previous measurements stored in MEMORY.	_____
 Full Battery	The battery power indicator during measurement.	_____
 Low Battery	The battery power is low when it blinks.	Replace all batteries with new ones, when the mark blinks.
<i>Err</i>	Unstable blood pressure due to movement during the measurement.	Try the measurement again. Remain very still during the measurement.
	The systolic and diastolic values are within 10 mmHg of each other.	Apply the cuff correctly, and try the measurement again.
	The pressure value did not increase during inflation.	
<i>Err</i> <i>CUF</i>	The cuff is not applied correctly.	
<i>Err</i> PUL. DISPLAY ERROR	The pulse is not detected correctly.	
SYS.	Systolic blood pressure in mmHg	_____
DIA.	Diastolic blood pressure in mmHg	_____
PUL./min.	Pulse per minute	_____
AM	Time in the morning	_____
PM	Time in the afternoon	_____
((••))	Alarm ON/OFF mark of the reminder	If you want to stop the sound, press any button.
 0123	EC directive medical device label	_____
	WEEE label	_____
	Manufacturer	_____
	EU-representative	_____
	Refer to instruction manual/booklet	_____
	Class II device	_____
	Polarity of DC jack	_____

Operation Mode

1. Normal Measurement With Storing Data

Press the **START** button. Blood pressure is measured and data is stored within the device. The device can store the last 90 sets of data in memory.

2. Recalling The Data

Press the **MEMORY** button to recall the data. The average data of all the measurements is displayed, as indicated in the figure at the right.

Then, each time the **MEMORY** button is pressed, the memory data is displayed from the most recent.

For details on recalling data, refer to “Recalling Memory Data”.

The device can store the last 90 sets of data in memory.

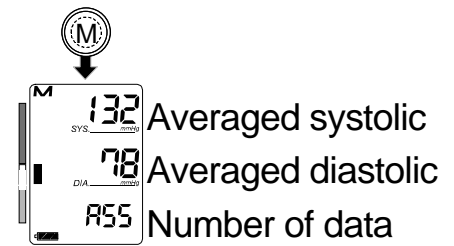

Average of all the data

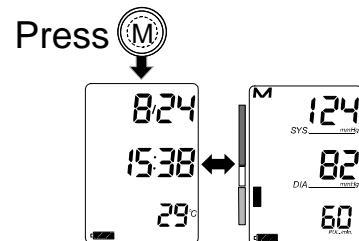

Most recent data:
Displays alternately every 3 seconds



3. Clearing The Data

Press and hold the **MEMORY** button until the “*M*” (memory) mark blinks to clear the stored data.

4. Measurement With The Desired Systolic Pressure

Refer to page 11 for measurement with the desired systolic pressure.

5. Switching The Unit Of Temperature

In the clock setting mode, when the dashes in the temperature displaying area are blinking, press the **PM** button to select °C or °F. Then, press the **AM** button or **START** button to return to the clock display.

For details on the clock setting mode, refer to “Adjusting The Built-in Clock” on page 7.

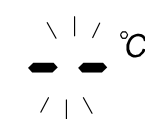

Select the unit of temperature



Using The Monitor

Installing / Changing The Batteries

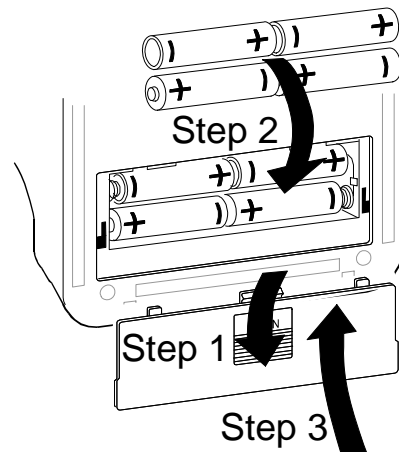
1. Slide the battery cover to open it.
2. Remove the used batteries and insert new batteries into the battery compartment as shown, taking care that the polarities (+) and (-) are correct.
3. Slide the battery cover to close it.
Use only R6P, LR6 or AA batteries.



CAUTION

- ❑ Insert the batteries as shown in the battery compartment. If installed incorrectly, the device will not work.
- ❑ When  (LOW BATTERY mark) blinks on the display, replace all batteries with new ones. Do not mix old and new batteries. It may shorten the battery life, or cause the device to malfunction.
- ❑  (LOW BATTERY mark) does not appear when the batteries are drained.
- ❑ Battery life varies with the ambient temperature and may be shorter at low temperatures.
- ❑ Use the specified batteries only.
- ❑ Remove the batteries if the device is not to be used for a long time. The batteries may leak and cause a malfunction.

Connecting The Air Hose

Insert the air connector plug into the air socket firmly.

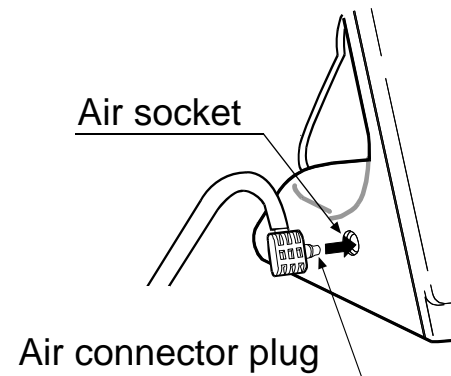

Connecting The AC Adapter

Insert the AC adapter plug into the DC jack. Then, insert the AC adapter into an electrical outlet.

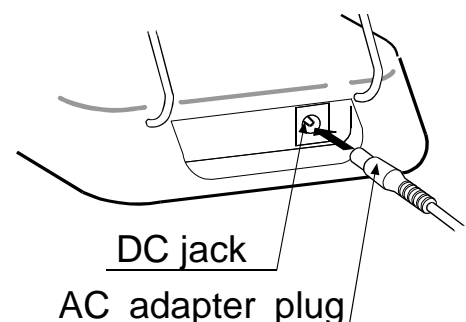

Using The Monitor

Adjusting The Built-in Clock

Adjust the clock prior to use.

1. Press and hold the **AM** button until the year starts blinking.
2. Select the year using the **PM** button. Press the **AM** button to set the current year and move to month/day selection. The date can be set anywhere between the years 2006 and 2056.
3. Select the month using the **PM** button. Press the **AM** button to set the current month and move to day selection.
4. Select the day using the **PM** button. Press the **AM** button to set the current day and move to hour/minute selection.
5. Select the hour using the **PM** button. Press the **AM** button to set the current hour and move to minute selection.
6. Select the minute using the **PM** button. (Press the **AM** button to go to the temperature unit selection mode. For details, refer to page 5.) Press the **START** button to set the current minute and activate the clock.

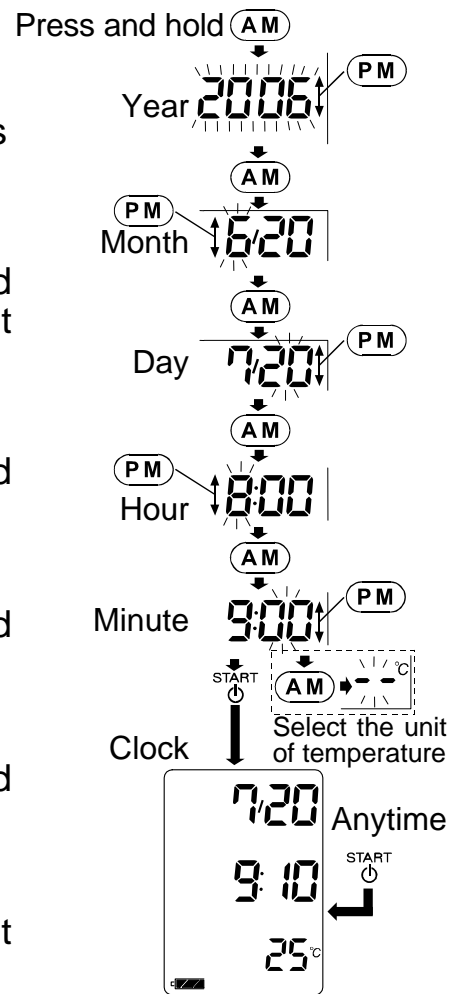

Setting Three Reminders

This device has 3 reminder alarms. You can set 3 different reminder alarms within a 24-hour period.

1. Press and hold the **AM** button until the year starts blinking. Then press the **MEMORY** button. "P-1" is shown at the bottom of the display.
2. Select the hour using the **PM** button and press the **AM** button to set the hour and move to minute selection. Press the **PM** button to set the minute and press the **AM** button or the **START** button to return to the clock display. The ((••)) mark appears on the display.
3. To set the second and third reminders, press the **MEMORY** button in the reminder setting mode to display "P-2" or "P-3". Repeat the above process to set each reminder.

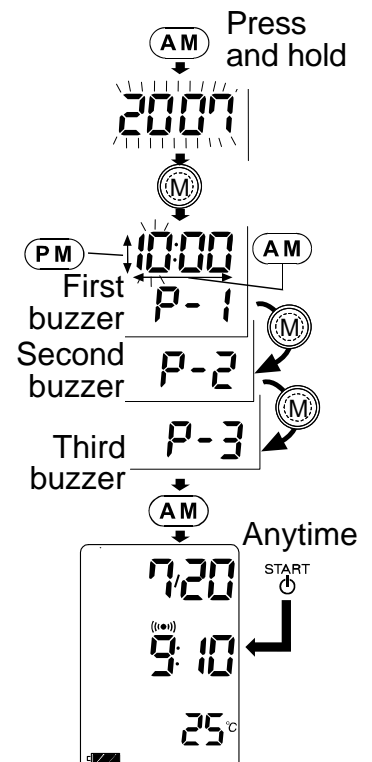

Using The Monitor

Alarm ON/OFF Mark On The Display

When the alarm is on, a “ ((•)) ” appears on the LCD. To turn the alarm off, simply press the **AM** button once.

The alarm will sound for 1 minute. To stop the alarm sound, press any button once.

Selecting The Correct Cuff Size

Using the correct cuff size is important for an accurate reading. If the cuff is not the proper size, the reading may yield an incorrect blood pressure value.

- ❑ The arm size is printed on each cuff.
- ❑ The arm cuff is a consumable. If it becomes worn, purchase a new one.

Arm Size	Recommended Cuff Size	Catalog Number
22 cm to 43 cm	Large adult cuff	CUF-U-LA
17 cm to 32 cm	Adult cuff	CUF-U-A

Arm size: The circumference of the biceps.

Note: Model UA-854 is not designed for using a small adult cuff.

Symbols that are printed on the cuff

Symbols	Function/Meaning	Recommended Action
□	Artery Position Mark	Set the □ mark on the artery of the upper arm or in line with the ring finger on the inside of the arm.
REF	Catalog Number	_____
LOT	Lot Number	_____

Applying The Arm Cuff

1. Wrap the cuff around the upper arm, about 1-2 cm above the inside of the elbow, as shown. Place the cuff directly against the skin, as clothing may cause a faint pulse, and result in a measurement error.
2. Constriction of the upper arm, caused by tightly rolling up a shirtsleeve, may prevent accurate readings.

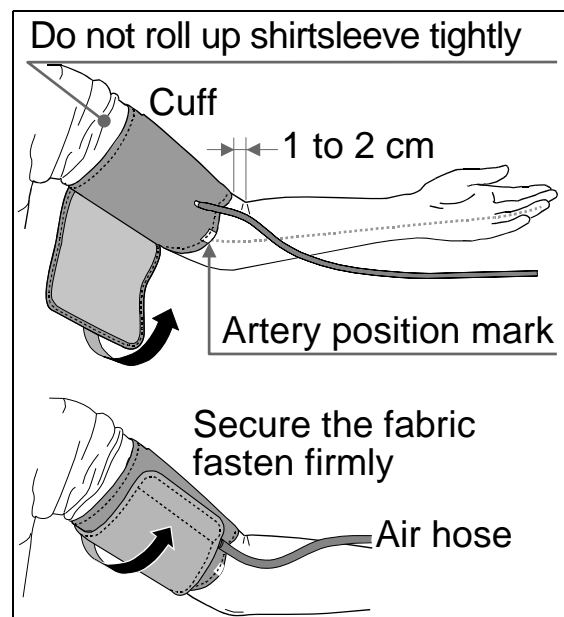

Using The Monitor

How To Take Proper Measurements

For the most accurate blood pressure measurement:

- Sit comfortably on a chair. Rest your arm on the table. Do not cross your legs. Keep your feet on the floor and straighten your back.
- Relax for about five to ten minutes before measurement.
- Place the center of the cuff at the same height as your heart.
- Remain still and keep quiet during measurement.
- Do not measure immediately after physical exercise or a bath. Rest for twenty or thirty minutes before taking the measurement.
- Try to measure your blood pressure at the same time every day.

Measurement

During measurement, it is normal for the cuff to feel very tight. (Do not be alarmed).

After Measurement

After measurement, press the START button to return to the clock display. Or the device returns to the clock display automatically one minute after measurement. Remove the cuff and record your data.

Note: Allow at least three minutes between measurements on the same person.

Measurements

Model UA-854 is designed to detect the pulse and to inflate the cuff to a systolic pressure level automatically.

If your systolic pressure is expected to exceed 230 mmHg, read "Measurement With The Desired Systolic Pressure" on the next page.

Normal Measurement

1. Place the cuff on the arm (preferably the left arm). Sit quietly during measurement.

2. Press the **START** button. The **START** button illuminates in orange in the morning (AM) and blue in the afternoon (PM).

0 (zero) is displayed blinking briefly. Then the display changes, as indicated in the figure at the right, as the measurement begins. The cuff starts to inflate. It is normal for the cuff to feel very tight. A pressure bar indicator is displayed, on the left edge of the display, during inflation.

Note: If you wish to stop inflation at any time, press the **START** button again.

3. When inflation is complete, deflation starts automatically and ♥ (heart mark) blinks, indicating that the measurement is in progress. Once the pulse is detected, the mark blinks with each pulse beat.

Note: If an appropriate pressure is not obtained, the device starts to inflate again automatically.

4. When the measurement is complete, the systolic and diastolic pressure readings and pulse rate are displayed. The cuff exhausts the remaining air and deflates completely.

5. Press the **START** button to return to the clock display. Or the device returns to the clock display automatically one minute after measurement.

Note: Allow at least three minutes between measurements on the same person.

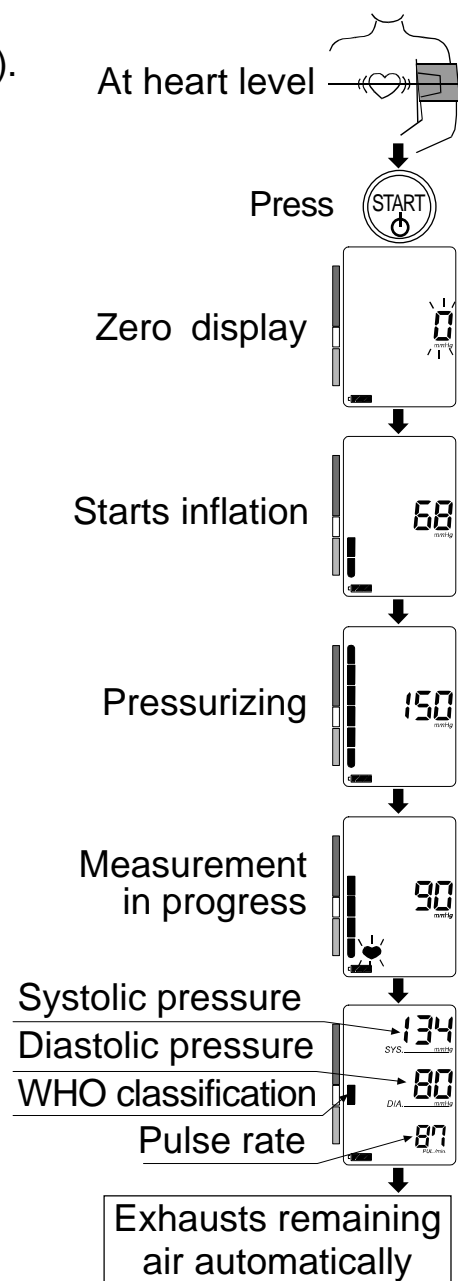

Measurements

Measurement With The Desired Systolic Pressure

If your systolic pressure is expected to exceed 230 mmHg, use this procedure.

1. Place the cuff on the arm (preferably the left arm).
2. Press and hold the **START** button until a number about 30 to 40 mmHg higher than your expected systolic pressure appears.
3. Release the **START** button to start measurement, when the desired number is reached. Then continue to measure your blood pressure as described on the previous page.

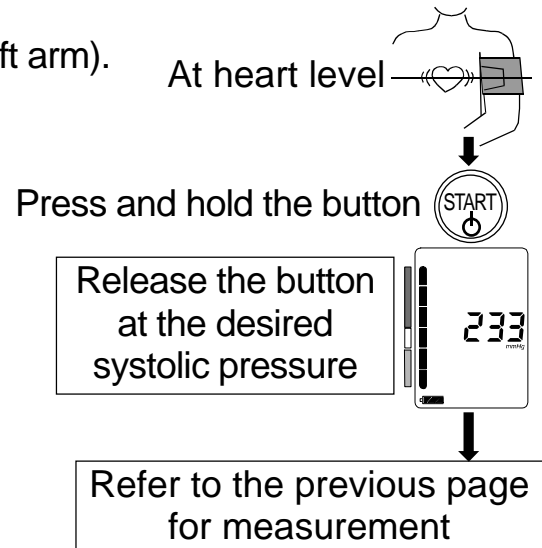

Notes For Proper Measurement

- Sit down in a comfortable position. Place the arm to be used for the measurement on a table or other support so that the center of the cuff will be at the same height as your heart.
- Relax for about five to ten minutes before taking a measurement. If you are excited or depressed by emotional stress, the measurement will reflect this stress as a higher (or lower) than normal blood pressure reading and the pulse reading will usually be faster than normal.
- An individual's blood pressure varies constantly, depending on what you are doing and what you have eaten. What you drink can have a very strong and rapid effect on your blood pressure.
- This device bases its measurements on the heartbeat. If you have a very weak or irregular heartbeat, the device may have difficulty determining your blood pressure.
- Should the device detect a condition that is abnormal, it will stop the measurement and display an error symbol. Refer to page 4 for the description of symbols.
- This blood pressure monitor is intended for use by adults only. Consult with your physician before using this device on a child. A child should not use this device unattended.

Recalling Memory Data

Note: This device stores the last 90 measurements in memory.

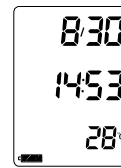

Clock display

1. Press the **MEMORY** button.
The average data of all the measurements and the number of data are displayed.

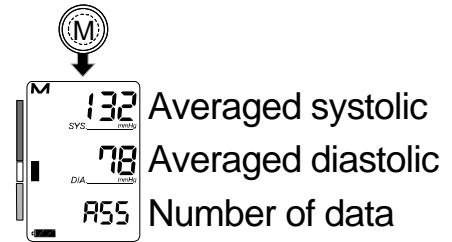

Average of all the data

2. Then, each time the **MEMORY** button is pressed, the memory data is displayed from the most recent.

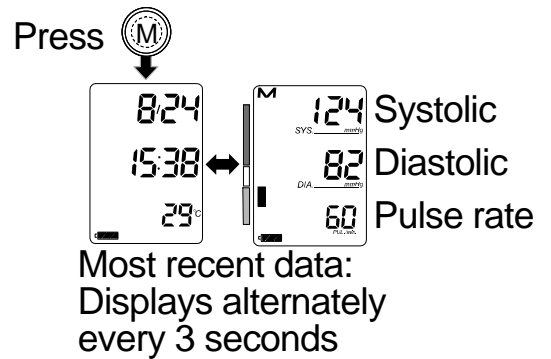

Most recent data:
Displays alternately every 3 seconds



3. After the last data is displayed, press the **MEMORY** button to return to the clock display.
Or the device returns to the clock display automatically after one minute.

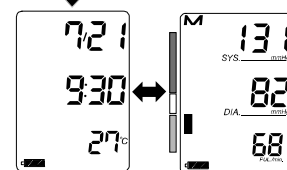

Last data (Oldest)

Press **MEMORY**, or after one minute



Clock display

START
Anytime

Recalling Memory Data

4. Press the following key to recall various data when the average data of all the measurements is displayed.

AM button To recall the average data during the AM. The **START** button illuminates in orange.
Then, each time the **AM** button is pressed, the memory data taken during the AM is displayed from the most recent. After the last data is displayed, the display returns to the clock display

PM button To recall the average data during the PM. The **START** button illuminates in blue.
Then, each time the **PM** button is pressed, the memory data taken during the PM is displayed from the most recent. After the last data is displayed, the display returns to the clock display

START button To display the clock.

When the **MEMORY** button is pressed at each display, the display returns to the average data of all the measurements

Clearing The Memory Data

5. Press and hold the **MEMORY** button until the “**M**” (memory) mark blinks to clear the stored data.

What Is An Irregular Heartbeat

Model UA-854 blood pressure monitor provides a blood pressure and pulse rate measurement even when an irregular heartbeat occurs. An irregular heartbeat is defined as a heartbeat that varies by 25% from the average of all heartbeats during the blood pressure measurement. It is important that you be relaxed, remain still and do not talk during measurements.

Note: We recommend contacting your physician if you see this ((♡)) indicator frequently.

Pressure Bar Indicator

The indicator monitors the progress of pressure during measurement.

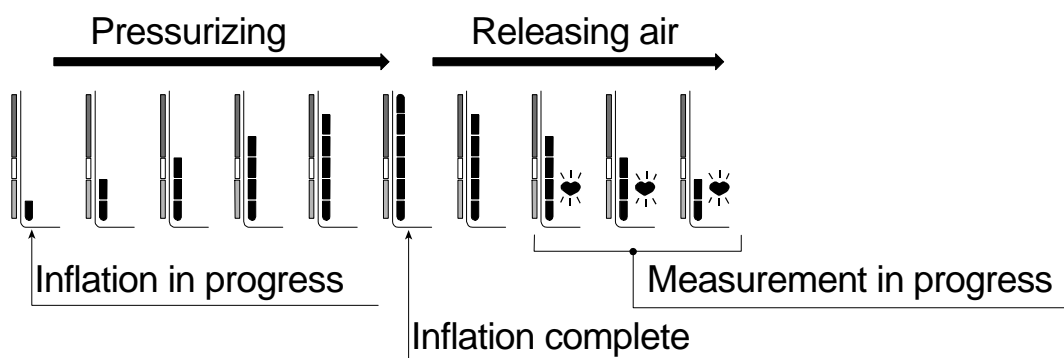

WHO Classification Indicator

Each segment of the bar indicator corresponds to the WHO blood pressure classification described on the next page.

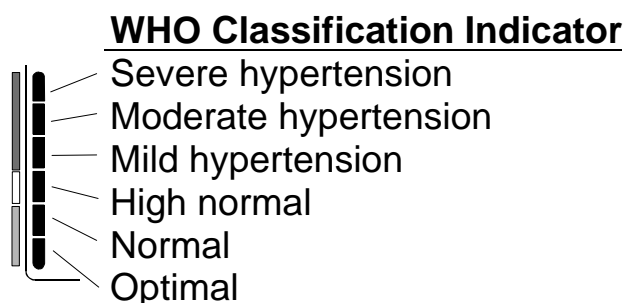

■ : The indicator displays a segment, based on the current data, corresponding to the WHO classification.

Example:

Moderate hypertension

Mild hypertension

High normal

About Blood Pressure

What Is Blood Pressure?

Blood pressure is the force exerted by blood against the walls of the arteries. Systolic pressure occurs when the heart contracts. Diastolic pressure occurs when the heart expands. Blood pressure is measured in millimeters of mercury (mmHg). One's natural blood pressure is represented by the fundamental pressure, which is measured first thing in the morning while one is still at rest and before eating.

What Is Hypertension And How Is It Controlled?

Hypertension, an abnormally high arterial blood pressure, if left unattended, can cause many health problems including stroke and heart attack. Hypertension can be controlled by altering lifestyle, avoiding stress, and with medication under a doctor's supervision.

To prevent hypertension or keep it under control:

- Do not smoke
- Exercise regularly
- Reduce salt and fat intake
- Have regular physical checkups
- Maintain proper weight

Why Measure Blood Pressure At Home?

Blood pressure measured at a clinic or doctor's office may cause apprehension and can produce an elevated reading, 25 to 30 mmHg higher than that measured at home. Home measurement reduces the effects of outside influences on blood pressure readings, supplements the doctor's readings and provides a more accurate, complete blood pressure history.

WHO Blood Pressure Classification

Standards to assess high blood pressure, without regard to age, have been established by the World Health Organization (WHO), as shown in the chart.

Reference Material: Journal of Hypertension 1999, Vol 17 No.2

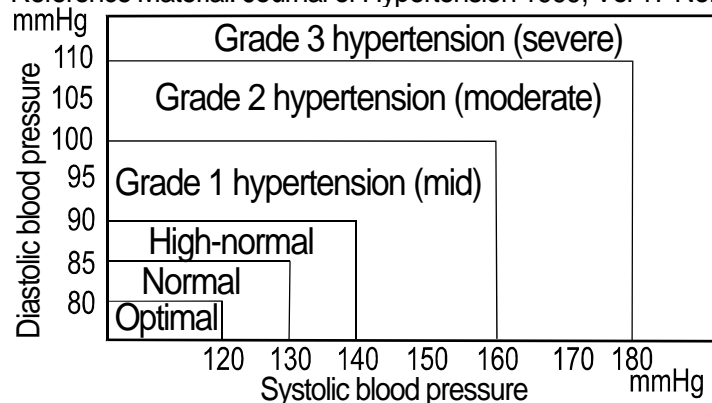

Blood Pressure Variations

An individual's blood pressure varies greatly on a daily and seasonal basis. It may vary by 30 to 50 mmHg due to various conditions during the day. In hypertensive individuals, variations are even more pronounced. Normally, the blood pressure rises while at work or play and falls to its lowest levels during sleep. So, do not be overly concerned by the results of one measurement.

Take measurements at the same time every day using the procedure described in this manual to get to know your normal blood pressure.

Regular readings give a more comprehensive blood pressure history. Be sure to note the date and time when recording your blood pressure. Consult your doctor to interpret your blood pressure data.

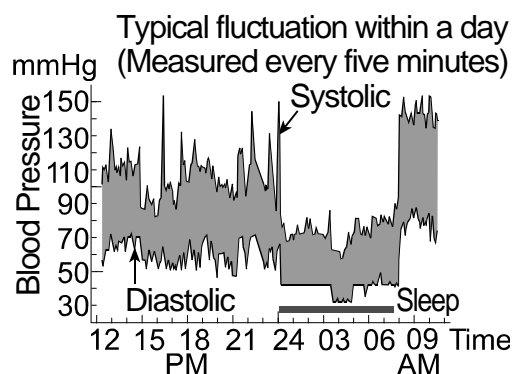

Troubleshooting

Problem	Possible Reason	Recommended Action
Nothing appears on the display, even when the power is turned on.	Batteries are drained.	Replace all batteries with new ones.
	Battery terminals are not in the correct position.	Reinstall the batteries with negative and positive terminals matching those indicated on the battery compartment.
The cuff does not inflate.	Battery voltage is too low.  (LOW BATTERY mark) blinks. If the batteries are drained completely, the mark does not appear.	Replace all batteries with new ones.
The unit does not measure. Readings are too high or too low.	The cuff is not applied properly.	Apply the cuff correctly.
	You moved your arm or body during the measurement.	Make sure you remain very still and quiet during the measurement.
	The cuff position is not correct.	Sit comfortably and still. Raise your hand so that the cuff is at the same level as your heart.
	_____	If you have a very weak or irregular heart beat, the device may have difficulty in determining your blood pressure.
Other	The value is different from that measured at a clinic or doctor's office.	Refer to "Why Measure Blood Pressure At Home".
	_____	Remove the batteries. Place them back properly and try the measurement again.

Note: If the actions described above do not solve the problem, contact the dealer. Do not attempt to open or repair this product, as any attempt to do so will make your warranty invalid.













Maintenance

Do not open the device. It uses delicate electrical components and an intricate air unit that could be damaged. If you cannot fix the problem using the troubleshooting instructions, request service from your dealer or from the A&D service group. The A&D service group will provide technical information, spare parts and units to authorized dealers.

The device was designed and manufactured for a long service life. However it is generally recommended to have the device inspected every 2 years, to ensure proper functioning and accuracy. Please contact either your authorized dealer or A&D for maintenance.

Technical Data

Type	UA-854
Measurement method	Oscillometric measurement
Measurement range	Pressure: 20 - 280 mmHg Pulse: 40 - 180 beats / minute
Measurement accuracy	Pressure: ± 3 mmHg Pulse: $\pm 5\%$
Temperature unit	$^{\circ}\text{C}$ or $^{\circ}\text{F}$
Temperature accuracy	$\pm 2^{\circ}\text{C}$ (-15°C to $+49^{\circ}\text{C}$)
Power supply	4 x 1.5V batteries (R6P, LR6 or AA) or AC adapter (TB-233) (Not included)
Number of measurements	Approx. 450 measurements, when AA alkaline batteries are used, with pressure value of 180 mmHg at room temperature of 23°C
Classification	Internally powered ME equipment (Supplied by batteries) / Class II (Supplied by adapter) Continuous operation mode
Clinical test	According to ANSI / AAMI SP-10 1987
EMC	IEC 60601-1-2: 2007
Memory	Last 90 measurements
Operating condition	$+10^{\circ}\text{C}$ to $+40^{\circ}\text{C}$ / 15%RH to 85 %RH 800-1060hPa
Transport / Storage conditions	-10°C to $+60^{\circ}\text{C}$ / 15%RH to 85 %RH

Dimensions	Approx. 150 [W] x 156 [H] x 126 [D] mm
Weight	Approx. 500 g, excluding the batteries
Applied part	Cuff Type BF 
Useful life	Device: 5 years (when used six times a day) Cuff: 2 years (when used six times a day)
Accessory AC adapter	The adapter is to connect the blood pressure monitor to a power source at home.
TB-233	Please contact your local A&D dealer for purchasing. The AC adapter is required to be inspected or replaced periodically.
TB-233C	Input: 100-240V Output: 6V  500mA     139°C  2A
TB-233BF	Input: 240V Output: 6V  500mA     139°C  2A

Accessories sold separately
Cuff

Catalog Number	Cuff Size	Arm Size
CUF-U-LA	Large adult cuff	22 cm to 43 cm
CUF-U-A	Adult cuff	17 cm to 32 cm

AC adapter

Catalog Number	Plug
TB-233C	Type C
TB-233BF	Type BF

Note: Specifications are subject to change without prior notice.

EMC table information is listed on our website:

http://www.aandd.jp/products/manual/medical/emc_acadapter_en.pdf



 **A&D Company, Limited**

1-243 Asahi , Kitamoto-shi, Saitama 364-8585, JAPAN
Telephone: [81] (48) 593-1111 Fax: [81] (48) 593-1119

 **A&D INSTRUMENTS LIMITED**

Unit 24/26 Blacklands Way, Abingdon Business Park, Abingdon, Oxfordshire OX14 1DY United Kingdom
Telephone: [44] (1235) 550420 Fax: [44] (1235) 550485

A&D ENGINEERING, INC.

1756 Automation Parkway, San Jose, California 95131, U.S.A.
Telephone: [1] (408) 263-5333 Fax: [1] (408)263-0119

A&D AUSTRALASIA PTY LTD

32 Dew Street, Thebarton, South Australia 5031, AUSTRALIA
Telephone: [61] (8) 8301-8100 Fax: [61] (8) 8352-7409